

 **ASSEMBLY INSTRUCTIONS**   
DO NOT THROW AWAY!

INSTRUCCIONES DE ENSEMBLAJE  
NO LA TIRE

INSTRUCTIONS DE MONTAGE  
NE PAS JETER

## Parts List

P1 - Board

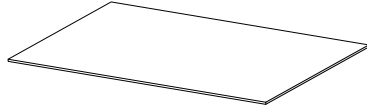

x3

P2 - Upright

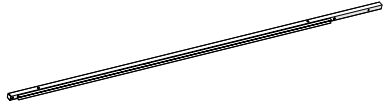

x6

P3 - Crossbar



x6

P4 - Foot

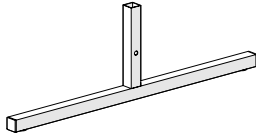

x6

## Hardware

A - M6 x 40mm Screw

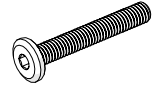

x24

B - M6 x 15mm Screw



x6

C - Plastic Endcap

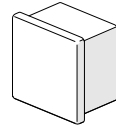

x6

D - Locking Casters

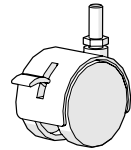

x3

E - Non-Locking Casters

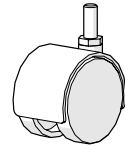

x3

F - Ganger (0,90,120)

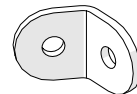

x18

G - Washer

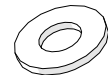

x12

H - Lock Nut



x12

I - Allen Wrench

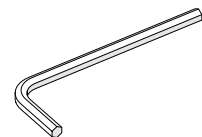

x1

## WARNINGS AND DISCLAIMERS

Review full assembly instructions and check that all parts are present before beginning assembly. Heavy or large furniture may require multiple persons in order to properly assemble. If you have questions regarding assembly, contact the manufacturer before continuing. Damage due to incorrect assembly may not be covered by warranty. Do not use product unless all screws are tight. Check all screws for tightness at least every six months. If parts are broken, missing, damaged, or worn, stop use of the product until repairs are made by your dealer using factory authorized parts.

## ADVERTENCIAS Y RENUNCIAS

Previo a comenzar el proceso de ensamblaje favor de revisar las instrucciones y asegurarse que cuenta con todas las partes y materiales necesarios. Es posible que los muebles grandes o pesados, requieran mas de una persona para ensamblarlos correctamente. Por favor contacte al fabricante directamente si tiene alguna duda o pregunta antes de continuar con el proceso de armado del producto. La garantía no cubrirá daños que ocurrieron por errores cometidos durante el proceso de ensamblaje. Todos los tornillos deben estar ajustados previo el uso del producto. Debe revisar los tornillos periódicamente, por lo menos cada seis meses y asegurarse de que estén bien ajustados. Por favor detenga el uso del producto si partes del producto se pierden, rompen, se deterioran por uso o se rompen. Favor de contactar a su distribuidor para que le envíen las partes necesarias o realice las reparaciones necesarias con partes autorizadas por el fabricante.

## AVERTISSEMENTS

Avant de commencer l'assamblage veuillez consulter les instructions complètes et vérifier si vous avez toutes les pièces nécessaires. Il est possible que plusieurs personnes soient nécessaires pour assemble des meubles grand ou lourds. En cas de doute sur l'assamblage contactez le fabricant avant de continuer. Les dommages encourus pendant l'assamblage ne seront pas couvert par la garantie. Ne pas utiliser le produit sans vérifier que tous les vis soient serrées. Vérifiez que les vis sont serrées au moins tous le 6 mois. Si aucune pièce se casse, manque, est endommagée ou usée, arrêtez d'utiliser de produit jusqu'à ce que le vendeur le repaire a l'aide de pièces autorisées par la fabricant.

## WARRANTY

For full product warranty details, please visit:

Para obtener información sobre la garantía del producto, consulte este sitio (ingles):

Pour plus d'informations sur la garantie du produit, consultez ce site (anglais):

<http://moorecoinc.com/warranty>

## CARE & MAINTENANCE

For questions on assembly or missing/damaged parts, please contact us using the following information.

Para preguntas sobre el ensamblaje o piezas faltantes o dañadas, por favor contáctenos usando la siguiente información.

Pour toute question sur le montage l'assamblage manquantes ou endommagées, veuillez nous contacter en utilisant les l'information ci-dessous.

Email:

[support@moorecoinc.com](mailto:support@moorecoinc.com)

Phone:

**1.800.749.2258**

(Monday - Friday, 8AM - 5PM

Central Time)

## PRODUCT REGISTRATION

To register your product for warranty, please visit:

Para registrar la garantía del producto, vea este sitio (en ingles):

Pour enregistrer la garantie de votre produit, consultez ce site (en anglais):

<https://moorecoinc.com/register>

## STEP 1

With Board, Uprights, and Crossbars laid out on a protective surface, slide pieces onto edges of Board until flush. Make sure side holes on Uprights are aligned with threaded inserts on either end of Crossbars.

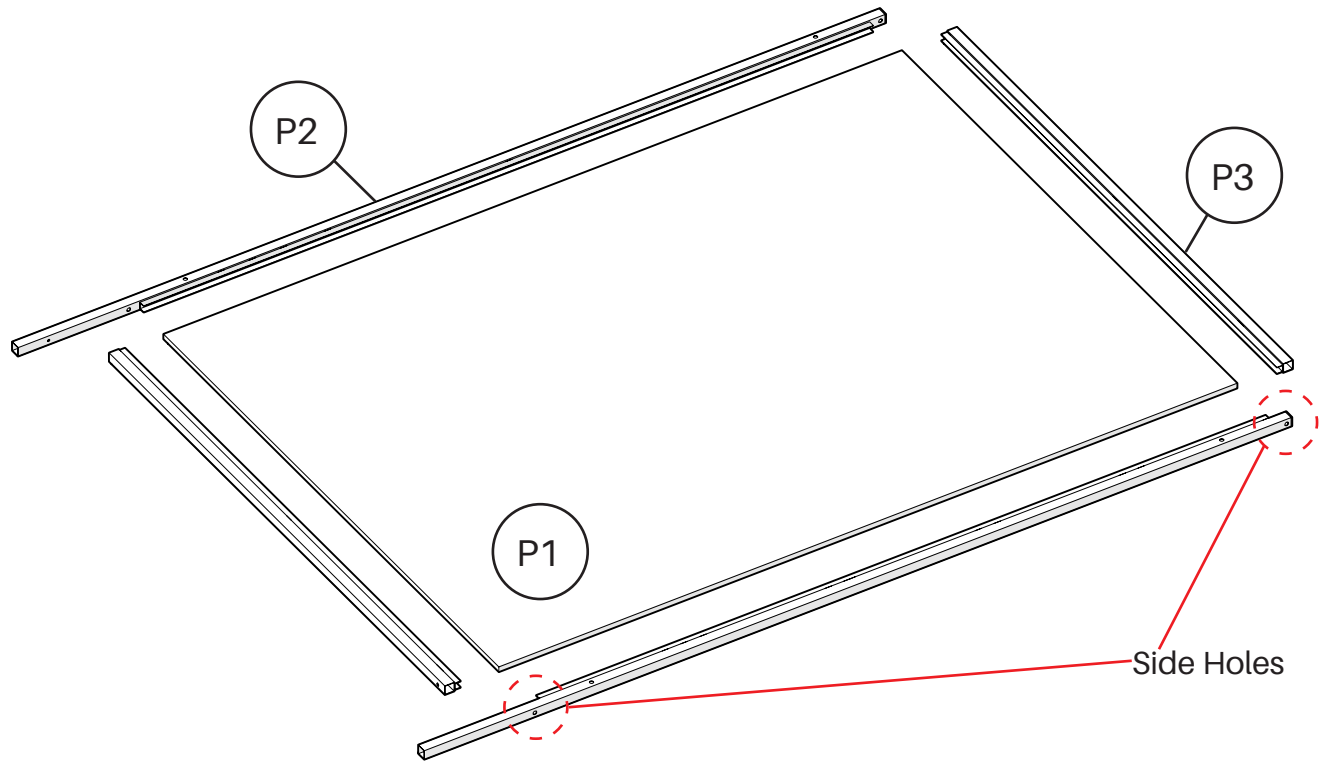

## STEP 2

With Crossbars and Uprights in position, secure in place with screws (A) and washers (C) inserted through side holes in Uprights. If setting up multiple connected panels insert Plastic Endcaps (E) to exposed ends of Uprights. If setting up individual mobile panel ignore Endcaps and proceed to last step.

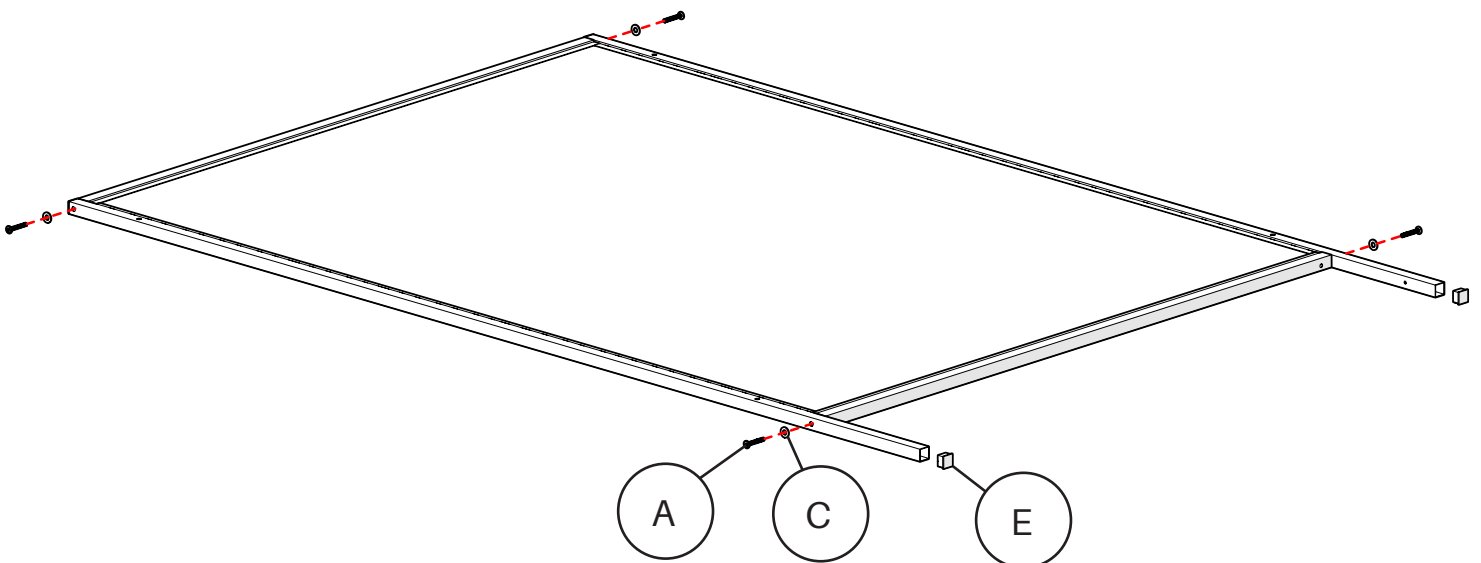

### STEP 3

Use Gangers with screws (A) and Lock Nuts (D) to connect display panels together in desired configuration. For radial configuration (see front page) use a total of six of the 120 degree style gangers.

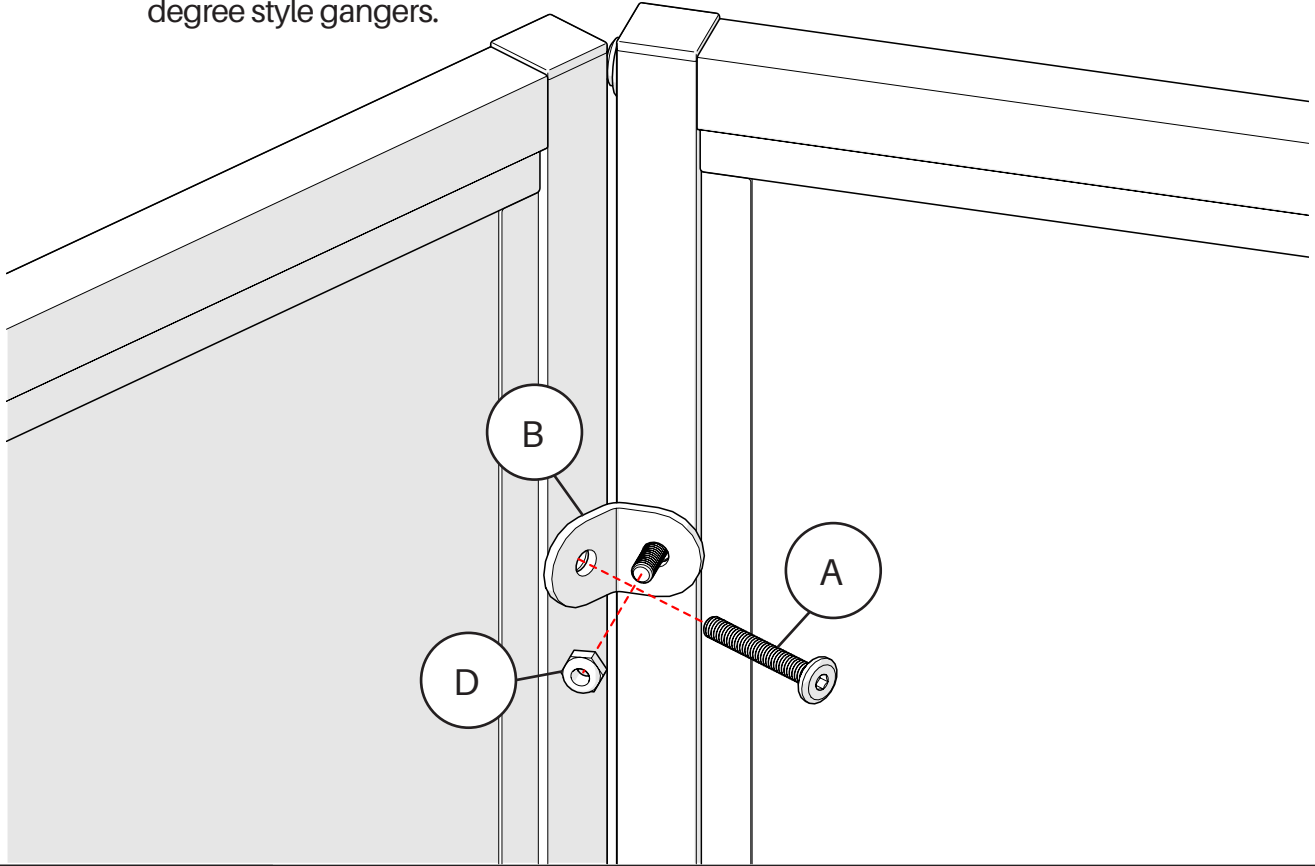

### Single Option

If setting up individual mobile floor panels slide Foot with Casters over bottom of Upright and secure with screw (B).

