

CONSTELLATION ALL FOAM SOFT SEATING - MOON

Part Number(s):
FM1MON1, FM1MON2

OTTOMAN (FM1MON1):

- Non-functioning zippered cover with safety breakaway slider
- Non-skid material on bottom of base
- Bonded nylon thread

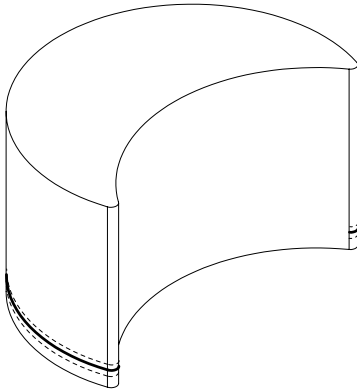
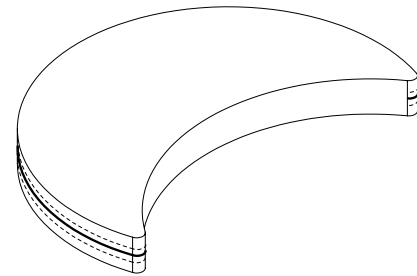

FLOOR PAD (FM1MON2):

- Non-functioning zippered cover with safety breakaway slider
- No plywood (extremely light/easy to move around)
- Bonded nylon thread

OVERVIEW:

Adaptive, mobile, all foam soft seating is the ultimate tool for creating a flexible, inclusive, active-learning environment. Lightweight and durable, all foam seating helps students move their bodies and discover their ideal position for learning. Imaginative, inventive shapes made of top-quality, high-density anti-microbial foam create a welcoming, comfortable atmosphere, encourage community and cooperation, improve the emotional well-being of students, and increase focus, productivity, and positivity.

SCS Indoor Advantage Gold Certified, products come assembled with safety zippers with breakaway sliders.

MOMENTUM FABRICS:

- For a wide variety of colorful QuickShip fabrics with guaranteed fast delivery, see page 4. For full information on Momentum fabrics and cleaning recommendations, visit momentumtextilesandwalls.com.

MOON OTTOMAN

FOOTPRINT & DIMENSIONS (INCHES):

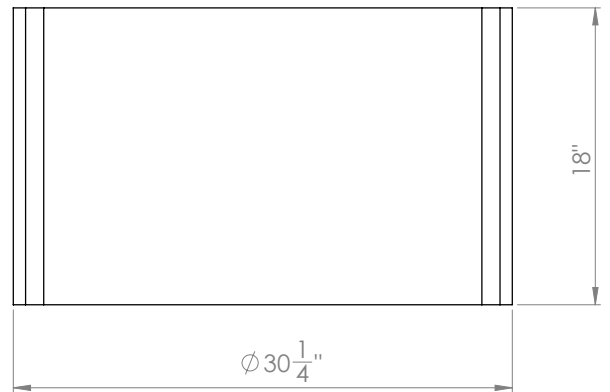
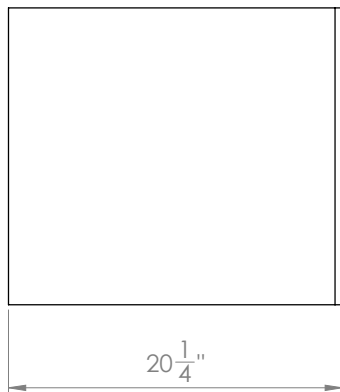
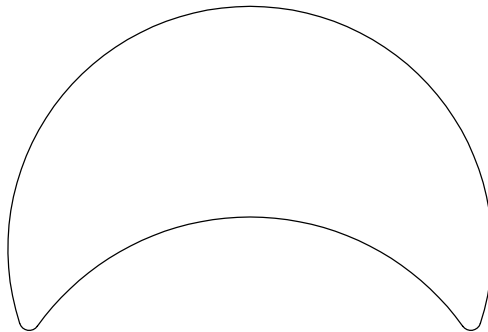
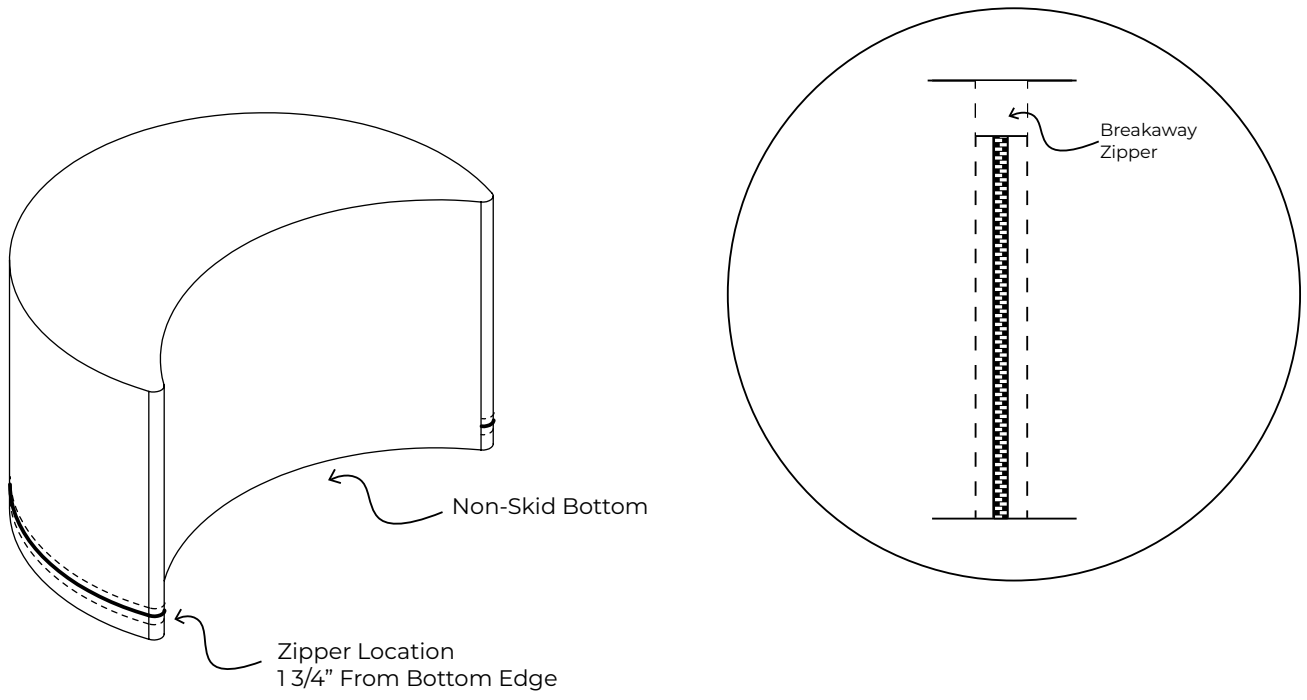

MOON FLOOR PAD

FOOTPRINT & DIMENSIONS (INCHES):

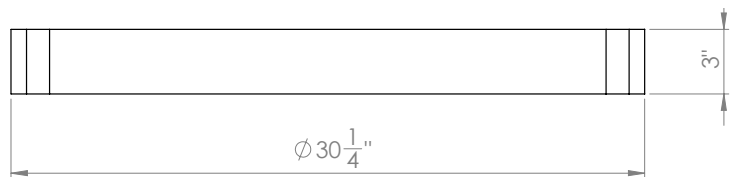
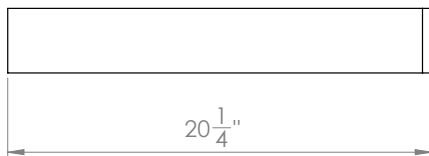
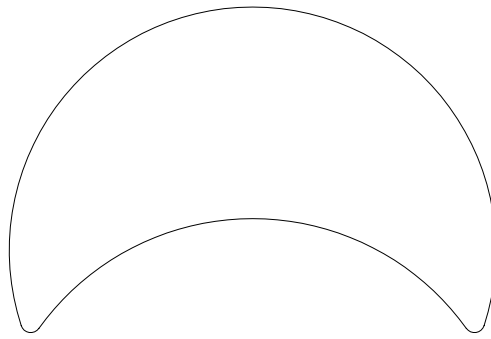
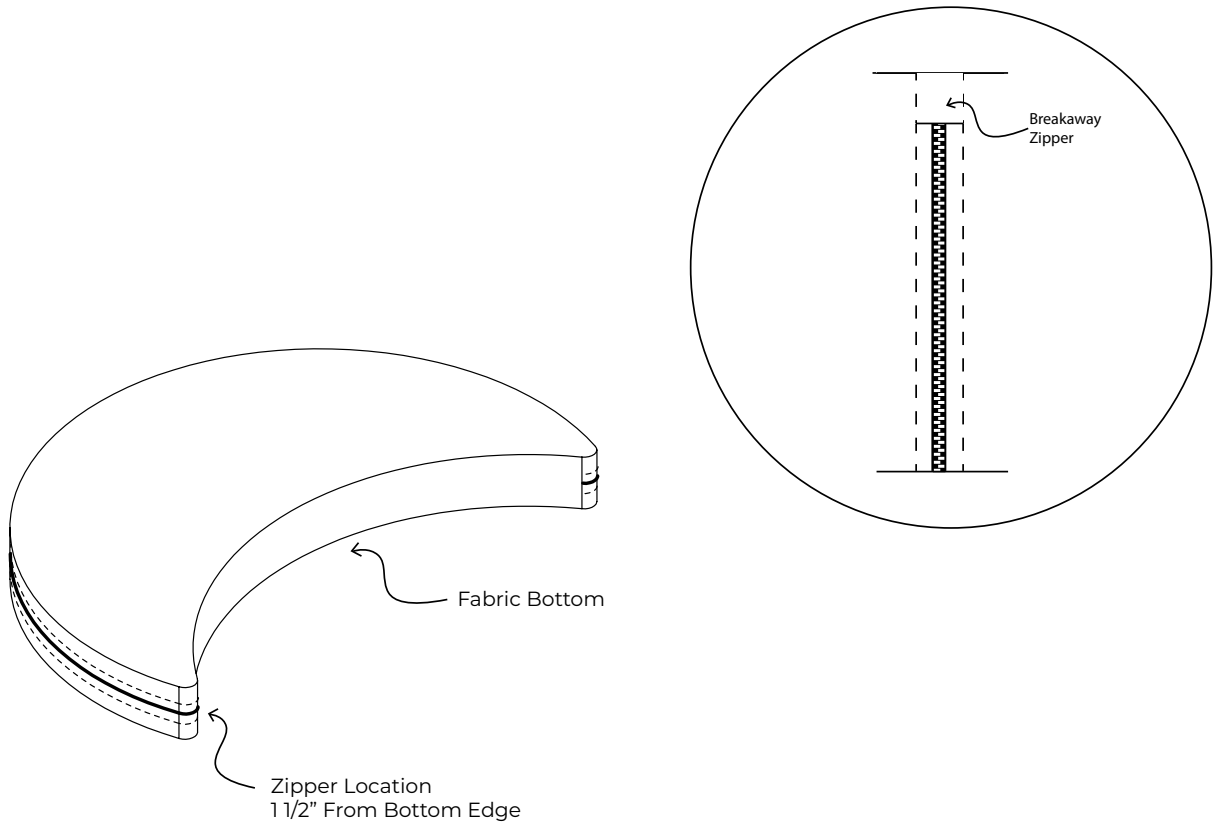

MooreCo TN Sustainability Initiatives



RECYCLING

Scrap Styrofoam and polyurethane foam are processed for use as fill materials in our Beanies by MooreCo soft seating.

Excess polyurethane foam is baled and sold to be remanufactured into other foam products such as carpet padding and floor mats.

Scrap cardboard from packaging materials are baled and sold for reprocessing into liner board for packaging materials.

MooreCo TN donates excess fabric and wood materials to local schools and daycare centers for use in arts and crafts.

MooreCo TN collects all paper, plastic and aluminum waste for recycling through local services.

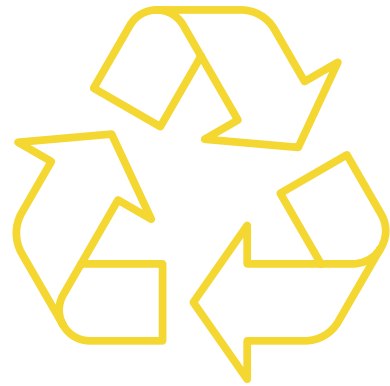

MATERIALS

MooreCo TN uses solvent free Simalfa water-based adhesives to bond our foam to the wood frames - it is GREENGUARD Gold Certified.

All plywood used is E1 / EPA TSCA Title VI / CARB Phase 2 Compliant.

All hardwoods used are provided from reforested sources.

All upholstery foams are highest quality and meet TB 117-2013 standards and contain no added fire retardant materials.

All our packaging materials contain at least 25% recycled content.

