

visual communication

PRODUCT GUIDE 2024

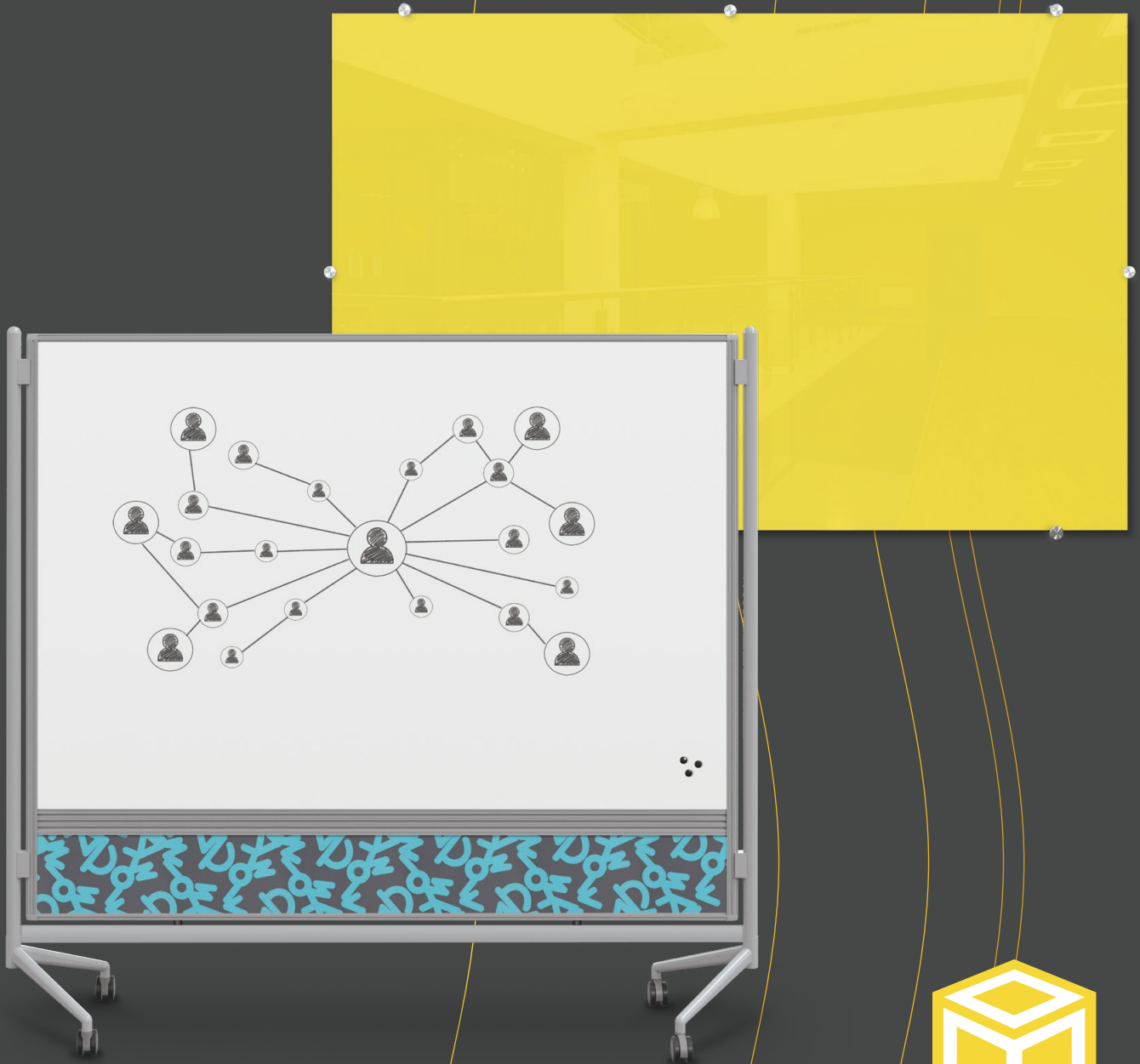

MOORECO™



MooreCo Inc.

2885 Lorraine Avenue | Temple, TX 76501

p: 800.749.2258 | f: 866.888.7483

www.moorecoinc.com

©2023–2024 MooreCo, Inc. All rights reserved.

MooreCo, Inc. reserves the right to correct pricing or copy errors.

Due to the current volatility in the price of raw and finished materials, please refer to our web site for the latest price list for pricing. Since individual items are subject to availability of materials from our suppliers, we reserve the right to limit quantities.

All shipping weights are nominal and may vary depending on items and quantities ordered. When ordering please contact MooreCo customer service at 1-800-749-2258 for accurate shipping rates and lead times.

Board dimensions reflect panel sizes prior to framing. All boards listed as 3'H x 4'W actually measure 33-3/4"H x 48"W due to shipping restrictions. Dimensions on all glass dry erase boards are estimated and may vary slightly.

Fabrics and finishes shown in images are chosen for illustration purposes only, and do not necessarily represent accurate scale, color, or best purpose of use. Please consult with our professional design team before selecting fabrics and finishes for your space.

Return Policy: A return authorization is required for the return of any merchandise. All requests for returns should be made within 90 (ninety) days of receipt of merchandise. The dealer may be responsible for restock and return freight charges. Returned products must be unused, undamaged, and in the original packaging. Please contact customer service for more details. Returned merchandise may be subject to a restocking fee.

Restocking Fee: Returned merchandise will be subject to a restocking fee.

Non-Returnable Merchandise: All boards and furniture which have been custom sized, custom framed, or customized to specifications will be considered a non-returnable item.

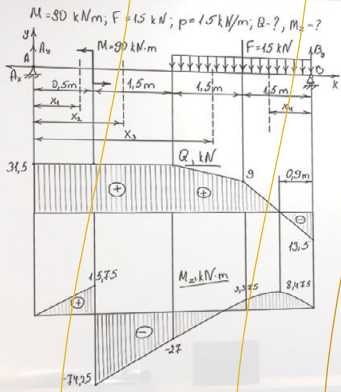

$$\sum \mathcal{M}_A = B_y \cdot 3.5 - p \cdot 2 \cdot 3.5 - F \cdot 1.5 + M = 0 \quad \sum F_x = A_x = 0$$

$$\sum \mathcal{M}_B = A_y \cdot 3.5 - M - p \cdot 2 \cdot 1.5 - F \cdot 1.5 = 0$$

$$B_y = \frac{p \cdot 2 \cdot 3.5 + F \cdot 1.5 - M}{3.5} = \frac{15 \cdot 2 \cdot 3.5 + 15 \cdot 1.5 - 80}{3.5} = 0.91 \text{ kN}$$

$$A_y = \frac{M + p \cdot 2 \cdot 1.5 + F \cdot 1.5}{3.5} = \frac{80 + 15 \cdot 2 \cdot 1.5 + 15 \cdot 1.5}{3.5} = 31.5 \text{ kN}$$

$$\sum F_y = A_y - p \cdot 2 - F + B_y = 31.5 - 15 \cdot 2 - 15 + 0.91 = 0$$

$$\text{I } (0 \leq x_1 \leq 0.5 \text{ m}) \quad Q_{x_1} = A_y = 31.5 \text{ kN}; \quad M_{x_1} = A_y \cdot x_1 = 31.5 \cdot x_1$$

$$M_{x_1=0.5} = 0; \quad M_{x_1=0.5} = 31.5 \cdot 0.5 = 15.75 \text{ kNm}$$

$$\text{II } (0.5 \text{ m} \leq x_2 \leq 2 \text{ m}) \quad Q_{x_2} = A_y - p \cdot x_2 = 31.5 \text{ kN}; \quad M_{x_2} = A_y \cdot x_2 - M = 31.5 \cdot x_2 - 80$$

$$M_{x_2=0.5} = 31.5 \cdot 0.5 - 80 = -74.25 \text{ kNm}$$

$$M_{x_2=2} = 31.5 \cdot 2 - 80 = -27 \text{ kNm}$$

$$\text{III } (2.0 \text{ m} \leq x_3 \leq 3.5 \text{ m}) \quad Q_{x_3} = A_y - p(x_3 - 1) = 31.5 - 15 \cdot x_3$$

$$M_{x_3} = A_y \cdot x_3 - M - p(x_3 - 1) \cdot (x_3 - 1) = 31.5 \cdot x_3 - 80 - 15 \cdot \frac{(x_3 - 1)^2}{2}$$

$$Q_{x_3=2} = 31.5 - 15 \cdot 2 = -31.5 \text{ kN}$$

$$Q_{x_3=3.5} = 31.5 - 15 \cdot 3.5 = -31.5 \text{ kN}$$

$$M_{x_3=2} = 31.5 \cdot 2 - 80 = -27 \text{ kNm}$$

$$M_{x_3=3.5} = 31.5 \cdot 3.5 - 80 - \frac{15 \cdot (3.5 - 1)^2}{2} = 3.75 \text{ kNm}$$

$$\text{IV } (0 \leq x_4 \leq 1.5) \quad Q_{x_4} = A_y - p \cdot x_4 = 31.5 - 15 \cdot x_4$$

$$M_{x_4} = A_y \cdot x_4 - \frac{p \cdot x_4^2}{2} = 31.5 \cdot x_4 - \frac{15 \cdot x_4^2}{2}$$

$$Q_{x_4=0} = 31.5 \text{ kN}; \quad Q_{x_4=1.5} = 31.5 - 15 \cdot 1.5 = 9.1 \text{ kN}$$

$$M_{x_4=0} = 0; \quad M_{x_4=1.5} = 31.5 \cdot 1.5 - \frac{15 \cdot 1.5^2}{2} = 30.25 \text{ kNm}$$

$$Q_{x_4=1.5} = 9.1 \text{ kN}$$

$$M_{x_4=1.5} = 31.5 \cdot 1.5 - \frac{15 \cdot 1.5^2}{2} = 30.25 \text{ kNm}$$

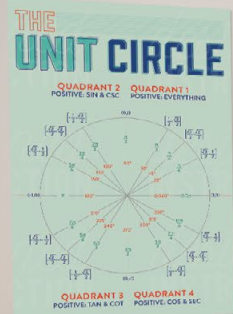

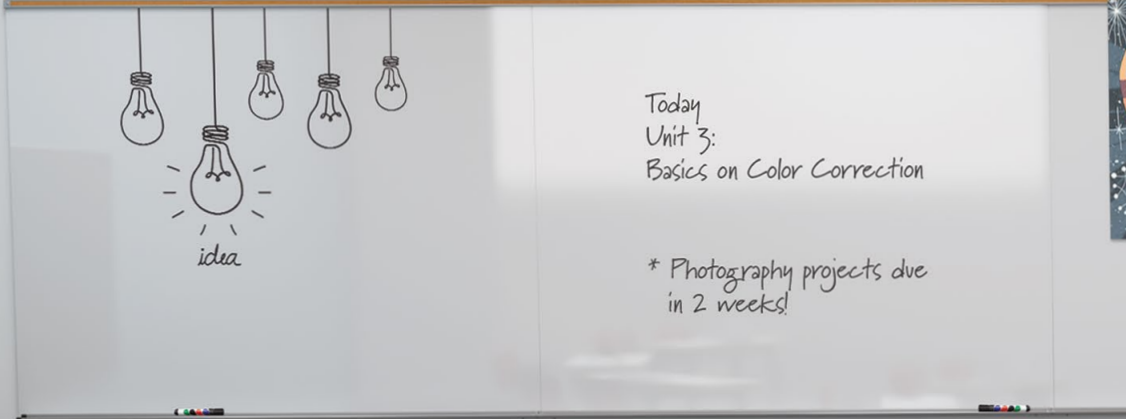

Today
Unit 3:
Basics on Color Correction

* Photography projects due
in 2 weeks!

! Markerboards



MARKERBOARDS: Glass Boards

Ex: A plane is flying east at 100 mph. The wind is blowing 20 mph toward 60° N of E. What is the resulting speed of the plane?

$\vec{P} = 100\mathbf{i}$
 $\vec{W} = 10\mathbf{i} + 10\sqrt{3}\mathbf{j}$

$\therefore \vec{R} = \vec{P} + \vec{W}$
 $= 100\mathbf{i} + (10\mathbf{i} + 10\sqrt{3}\mathbf{j})$
 $\vec{R} = 110\mathbf{i} + 10\sqrt{3}\mathbf{j}$

Steel-backed glass surface accepts rare earth magnets!

50 year limited warranty

Visionary® Hierarchy Magnetic Glass Board

- Reflect on your true colors. Ultra modern glass boards now available in multiple colors to accentuate any space.
- Borderless and seamless, the board is available in fresh modern colors to match your environment and our line of Hierarchy furniture.
- Tempered safety glass ideal for use in any environment. Compatible with any dry erase or wet erase marker, grease pen, etc. Easily cleans without ghosting or staining. Accepts rare earth magnets.
- Attractive stainless steel mounting standoffs. Mounts are standard with a silver finish.
- Includes aluminum accessory tray and set of magnets. Glass accessory tray available separately.
- Fifty year limited warranty. SCS Indoor Advantage Gold Certified.

Glass color options:

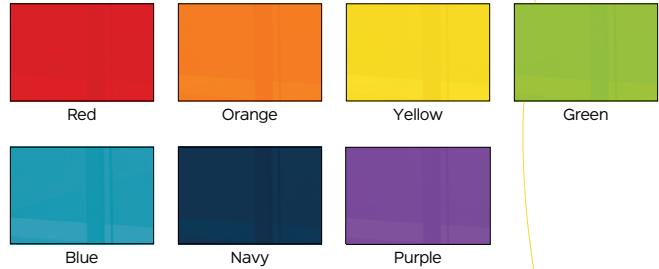

PART NO.	DIMENSIONS	SHIP WT.
83844-XXXX	35.4"H x 47.2"W	42 lbs
83845-XXXX	47.2"H x 70.9"W	79 lbs
83846-XXXX	47.2"H x 94.5"W	104 lbs

[VIEW ONLINE](#)

Steel-backed glass surface accepts rare earth magnets!

50 year limited warranty

Insight® Magnetic Glass Board

- Add seamless style to any environment with low iron glass. Low iron glass reduces the green cast of regular glass, providing a more true white coloration.
- Durable steel backing allows the board to accept rare earth magnets. Concealed mounting devices give a seamless appearance. Includes glass accessory tray, set of rare earth magnets, and eraser.
- Fifty year limited warranty. SCS Indoor Advantage Gold Certified.

PART NO.	DIMENSIONS	SHIP WT.
83908	35.4"H x 47.2"W	42 lbs
83906	47.2"H x 59.7"W	75 lbs
83909	47.2"H x 70.9"W	88 lbs
83910	47.2"H x 94.5"W	104 lbs

[VIEW ONLINE](#)

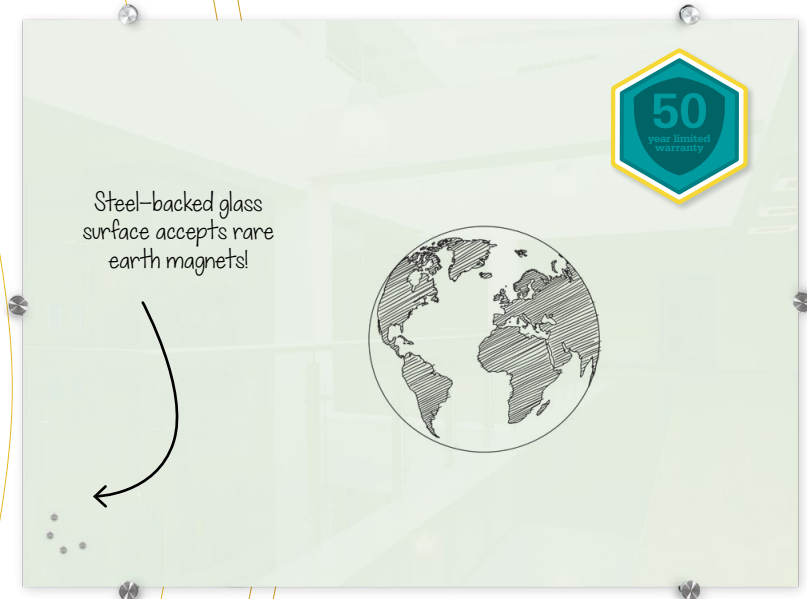

Visionary® Magnetic Glass Board

- A contemporary communication tool. Ultra glossy magnetic markerboard provides exceptional dry erase performance.
- Borderless and seamless, standard in glossy white. Custom colors and graphics printing available.
- Tempered safety glass ideal for use in any environment. Easily cleans without ghosting or staining. Accepts rare earth magnets.
- Stainless steel mounting standoffs.
- Includes set of magnets and accessory tray.
- Fifty year limited warranty. SCS Indoor Advantage Gold Certified.

[VIEW ONLINE](#)

PART NO.	ITEM	DIMENSIONS	SHIP WT.
83843	Gloss White	23.6"H x 35.4"W	19 lbs
83844	Gloss White	35.4"H x 47.2"W	42 lbs
83841	Gloss White	47.2"H x 47.2"W	46 lbs
83845	Gloss White	47.2"H x 70.9"W	79 lbs
83846	Gloss White	47.2"H x 94.5"W	104 lbs

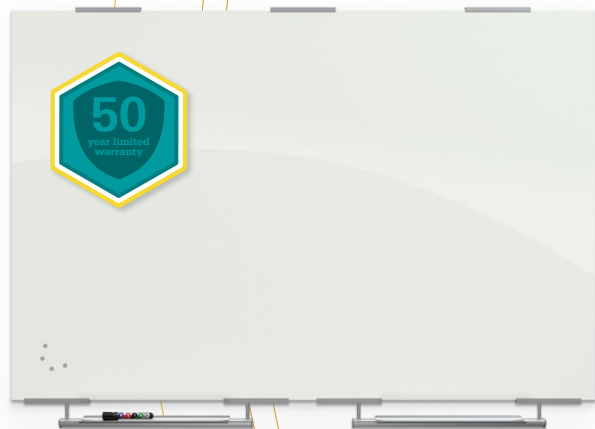

Visionary® Board + Exo Tray System

- Upgrade your expectations. Finally a glass board with an ultra stylish accessory tray. The Exo Tray System provides clean and functional anodized aluminum accessory storage.
- Tempered safety glass ideal for use in any environment. Easily cleans without ghosting or staining. Accepts rare earth magnets. Available in standard and custom color and graphic options.
- Fifty year limited warranty. SCS Indoor Advantage Gold Certified.

PART NO.	DIMENSIONS	SHIP WT.
83843-1X576	23.6"H x 35.4"W	19 lbs
83844-1X576	35.4"H x 47.2"W	42 lbs
83845-2X576	47.2"H x 70.9"W	79 lbs
83846-2X576	47.2"H x 94.5"W	105 lbs

[VIEW ONLINE](#)

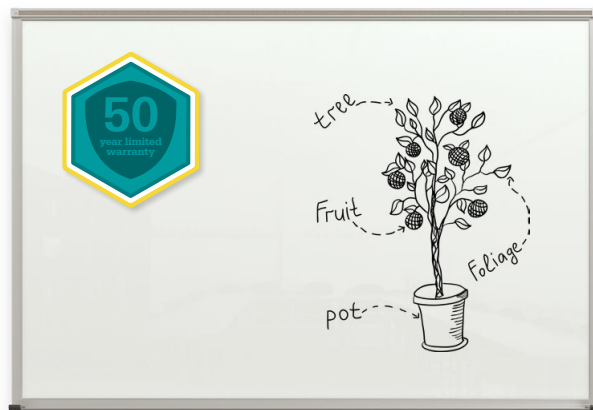

Framed Magnetic Glass Board

- Our Best in Class® glass board with a safety edge. Framed glass surface is a superior writing and erasing surface.
- Anodized aluminum trim includes a full-length tackable map rail with a colored cork insert, and a full-length accessory tray with rubber Dura-Safe® end caps to eliminate sharp edges.
- Trim is designed with vinyl glazing so that aluminum does not contact glass at all. Mitered corners are attached with friction locks.
- Fifty year limited warranty. SCS Indoor Advantage Gold Certified.

PART NO.	DIMENSIONS	SHIP WT.
14800	35.4"H x 47.2"W	51 lbs
14801	47.2"H x 70.9"W	90 lbs
14802	47.2"H x 94.5"W	120 lbs

[VIEW ONLINE](#)

MARKERBOARDS: Porcelain Steel Boards

Porcelain Steel Whiteboard

- Tried and true porcelain steel provides exceptional writability, erasability, and versatility.
- Magnetic porcelain steel whiteboards are engineered for superior color contrast with dry erase markers. Standard gloss dry erase surface provides superior writability and erasability with no ghosting.
- Reduced surface light distortion enhances visibility to provide optimum eye comfort. Steel is permanently laminated to a lightweight substrate for stability and durability.
- Available in multiple size and frame options to fit any environment and any need. Call for custom options.
- Limited lifetime warranty. SCS Indoor Advantage Gold Certified.

PART NO.	DIMENSIONS	SHIP WT.
A. DELUXE ALUMINUM TRIM		
202AB	2'H x 3'W	20 lbs
202AC	3'H x 4'W	36 lbs
202AD	4'H x 4'W	69 lbs
202AF	4'H x 5'W	84 lbs
202AG	4'H x 6'W	94 lbs
202AH	4'H x 8'W	120 lbs
202AK	4'H x 10'W	146 lbs
202AM	4'H x 12'W	194 lbs
202AP	4'H x 16'W	243 lbs
202AJ	5'H x 8'W	147 lbs
202AL	5'H x 10'W	195 lbs
202AN	5'H x 12'W	224 lbs
202AQ	5'H x 16'W	308 lbs
B. ULTRA TRIM		
2029B	2'H x 3'W	20 lbs
2029C	3'H x 4'W	36 lbs
2029D	4'H x 4'W	69 lbs
2029G	4'H x 6'W	94 lbs
2029H	4'H x 8'W	120 lbs
C. MUSIC LINE BOARD (DELUXE ALUMINUM)		
202AG-S1	4'H x 6'W	94 lbs
202AH-S1	4'H x 8'W	120 lbs

[VIEW ONLINE](#)

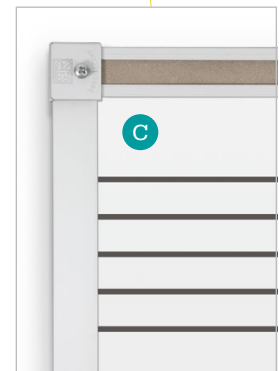
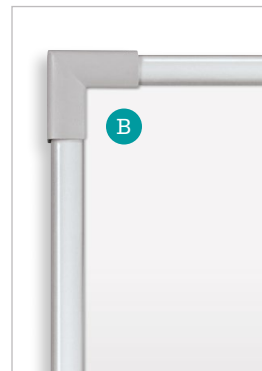
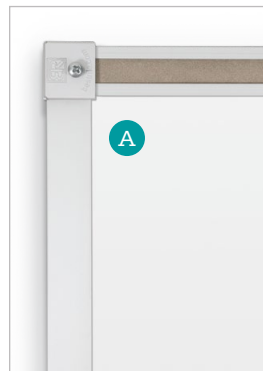
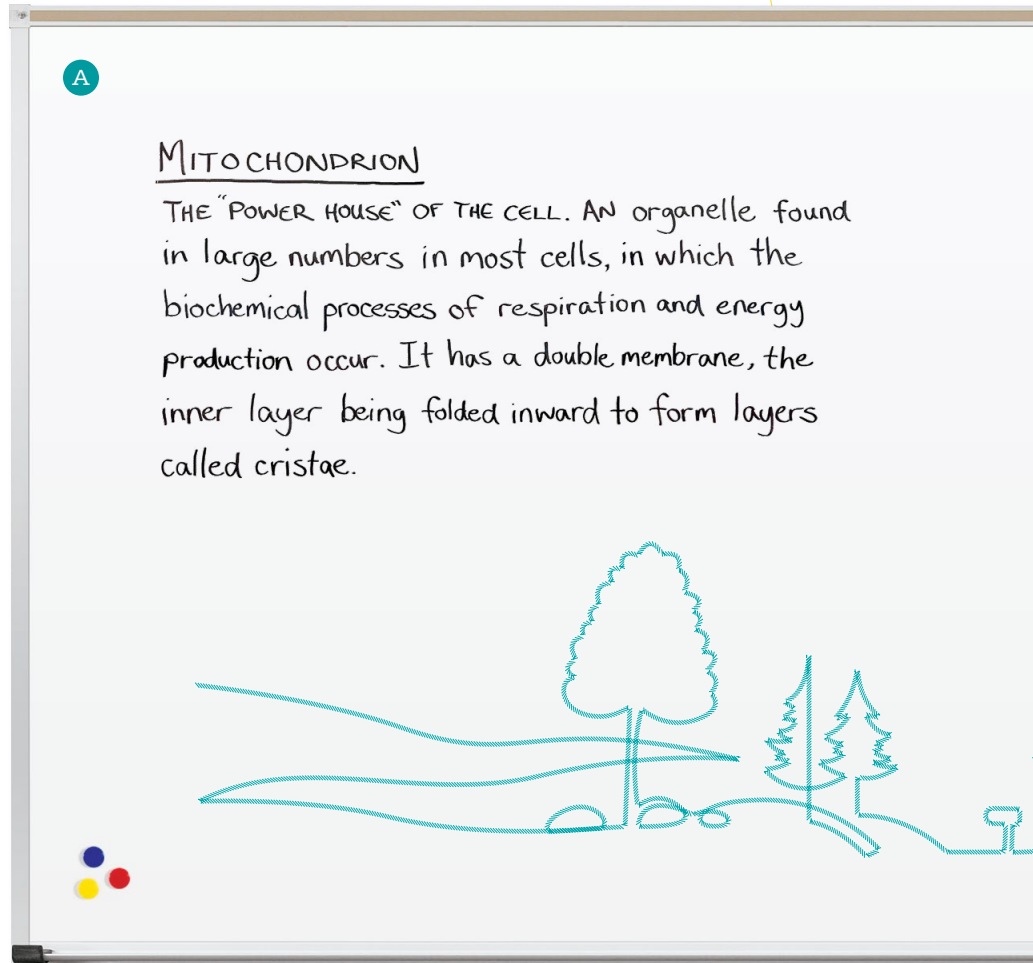

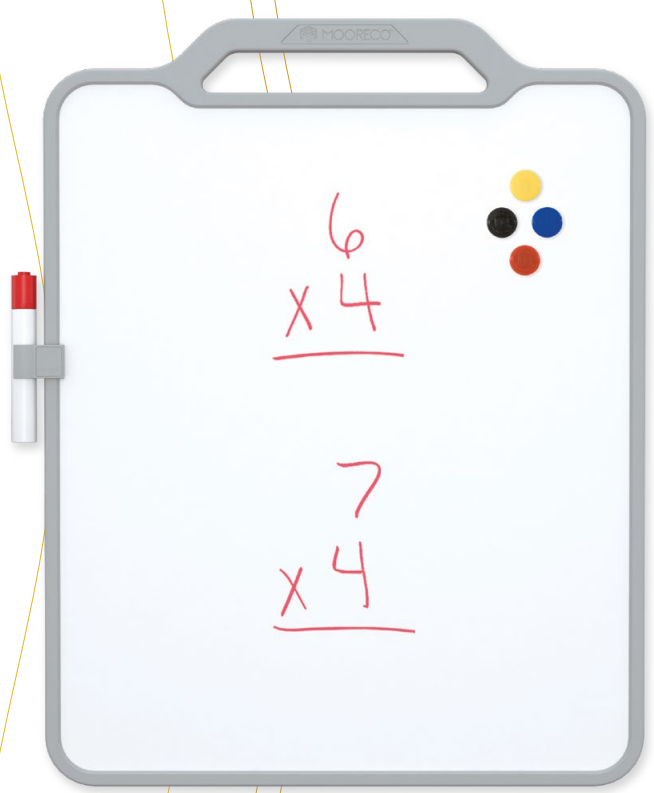

Compass Porcelain Steel Lapboard

- Group learning and sharing made easy. Porcelain lapboards are versatile, erasable, and make learning fun.
- Compact magnetic porcelain steel hand-held panels provide easy group communication and collaboration.
- Designed to work with a wide variety of accessories, giving you maximum flexibility for classroom activities and projects.
- Accessories include marker trays, marker clips, clamp mounts for desktop use (fit desktops from 3/4" to 1-3/4" thick), and wall mounts.
- SCS Indoor Advantage Gold Certified.

PART	DESCRIPTION	WT.
PRODUCT		
70501	Lapboard (set of 4)	16 lbs
70502	Docking Channel	2 lbs
70503	Single Channel + Tray	2 lbs
70504	Double Channel + Tray	2 lbs
70505	Wall Mount	2 lbs
70506	Marker Clip	2 lbs
70507	Desktop Clamp Mount	2 lbs

[VIEW ONLINE](#)

MARKERBOARDS: Porcelain Steel Boards



Interactive Projector Board

- The special construction of the Interactive Projector Board provides the flatness required for the best performance of your interactive projector.
- With a flatness guarantee <3mm across the board surface, the board can be used on carts or walls and still achieve the projector manufacturer's flatness requirements.
- Surface is engineered to minimize visual strain from anywhere in the room. Magnetic surface provides even more versatility, and the low profile aluminum Brio trim is a modern addition.
- Limited lifetime warranty. SCS Indoor Advantage Gold Certified.

PART NO.	PART NO.	DIMENSIONS	SHIP WT.
STANDARD	LOW GLOSS		
2G5KG-25	2G5KG-26	4'H x 6'W	85 lbs
2G5KH-25	2G5KH-26	4'H x 8'W	115 lbs
2G5KJ-25	2G5KJ-26	5'H x 8'W	137 lbs
2G5KL-25	2G5KL-26	5'H x 10'W	177 lbs

VIEW ONLINE





Interactive Projector Board + Whiteboard System

- Take advantage of the full breadth of your classroom or training room with the flexibility, functionality, and superior quality of projection steel whiteboard system designed specifically for the updated technology and changing needs of the modern classroom.
- All surface materials are optimized for smooth writing, clean erasing, and clear projection. Magnetic porcelain steel surfaces guarantee true long life and erasability.
- Main board has specially constructed board flatness for compatibility with interactive projectors. Side boards offer use of the whiteboard, or side notation while projecting.
- Limited lifetime warranty. SCS Indoor Advantage Gold Certified.



[VIEW ONLINE](#)



PART NO.	OVERALL DIMS	CENTER DIMS	SIDE DIMS	SHIP WT.
76441	4H x 10W	4H x 8W	4H x 1W	202 lbs
76442	4H x 12W	4H x 8W	4H x 2W	228 lbs
76447	4H x 14W	4H x 8W	4H x 3W	263 lbs
76443	4H x 16W	4H x 8W	4H x 4W	291 lbs
76448	4H x 18W	4H x 8W	4H x 5W	331 lbs
76449	4H x 20W	4H x 8W	4H x 6W	359 lbs
76444	5H x 10W	5H x 8W	5H x 1W	272 lbs
76445	5H x 12W	5H x 8W	5H x 2W	306 lbs
76450	5H x 14W	5H x 8W	5H x 3W	340 lbs
76446	5H x 16W	5H x 8W	5H x 4W	376 lbs
76451	5H x 18W	5H x 8W	5H x 5W	412 lbs
76452	5H x 20W	5H x 8W	5H x 6W	454 lbs



MARKERBOARDS: Small Boards / Combination Boards



Economy Lapboard

- Make group interaction fun and positive to bring out the best in your students!
- Available in handy sets of 24 for any size classroom, Economy Lapboards make student interaction and group activities easy, fun, and informative.
- Featuring a lightweight and easy to use dry erase surface measuring 9"H x 12"W, the board is perfect for spelling practice, math, games, or any other group activity.
- Slim size makes easy and compact storage.
- SCS Indoor Advantage Gold Certified.

PART NO.	DESCRIPTION	SHIP WT.
629-24	Set of 24	10 lbs

[VIEW ONLINE](#)

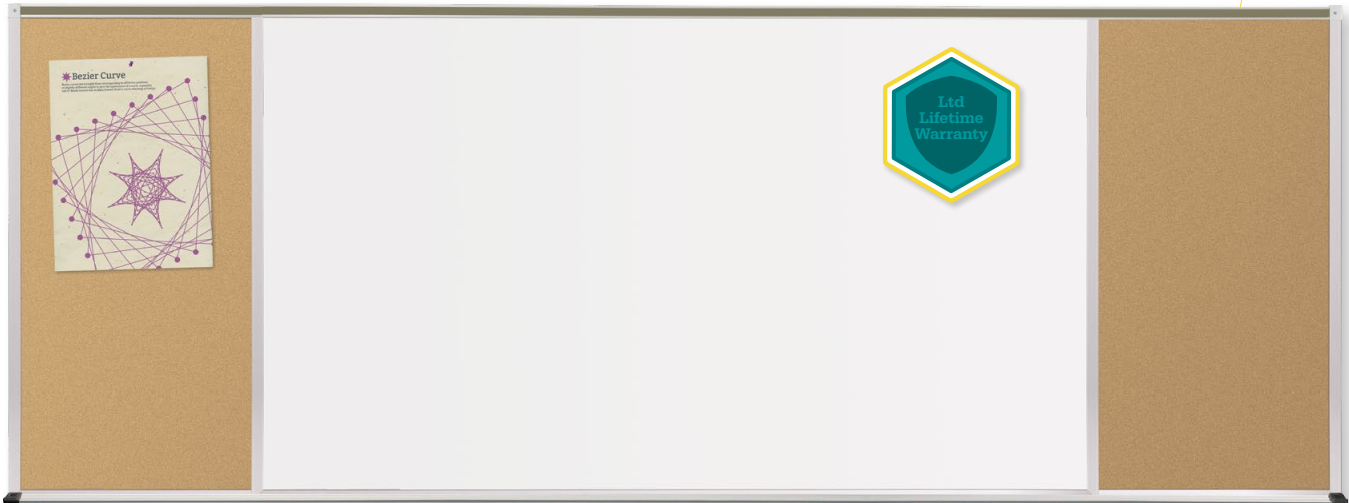

Combination & Combo-Rite Boards

- Combine porcelain steel markerboard and tackboard into one durable and versatile unit. Ideal for any classroom environment.
- All-in-one Combination Boards feature anodized aluminum trim with full-length tackable map rail and full-length accessory tray with Dura-Safe® rubber end caps.
- Or opt for the modular Combo-Rite Board. The surfaces can be changed or replaced when worn or damaged, saving time and money. Anodized aluminum trim features easy to use H-channels to attach panels together, also enabling easy disassembly for panel replacement.
- Available in a variety of sizes and panel configurations to fit your needs.
- Limited lifetime warranty on porcelain steel. Ten year limited warranty on tackboard. SCS Indoor Advantage Gold Certified.

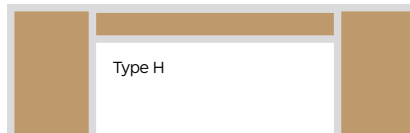
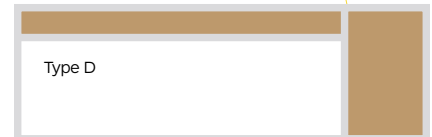
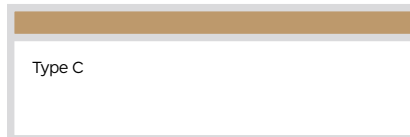

[VIEW ONLINE](#)

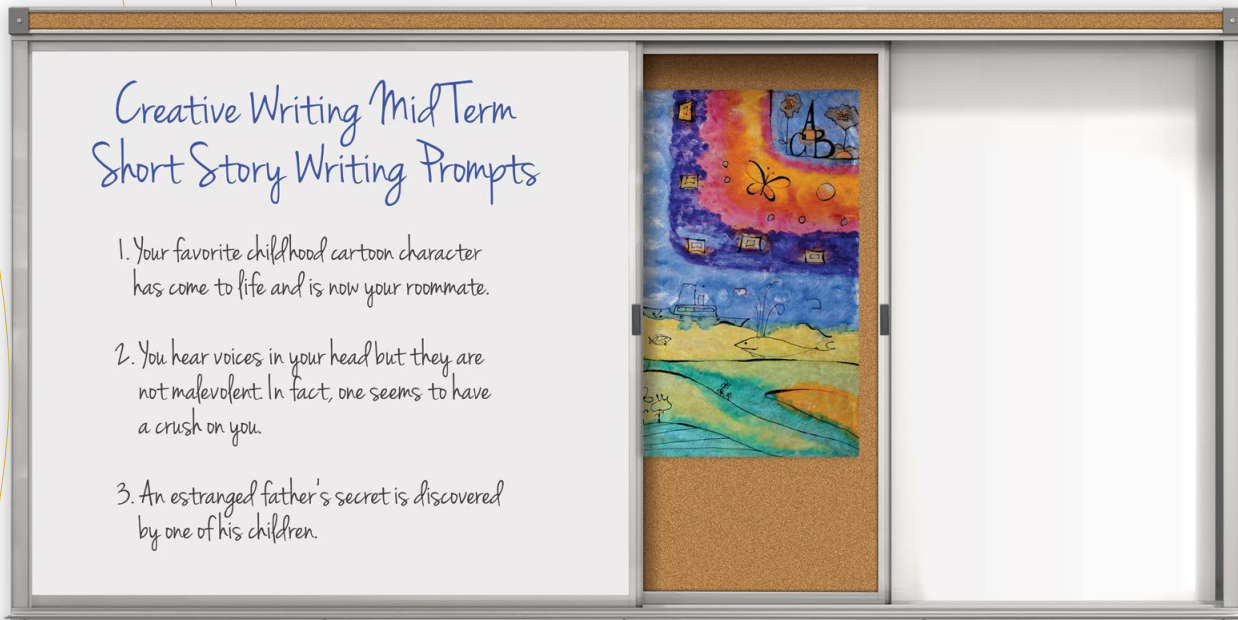

Creative Writing Mid Term Short Story Writing Prompts

1. Your favorite childhood cartoon character has come to life and is now your roommate.
2. You hear voices in your head but they are not malevolent. In fact, one seems to have a crush on you.
3. An estranged father's secret is discovered by one of his children.

Horizontal Sliding Board

- A better choice Across the Board!® Get the maximum use out of your presentation and instruction space. Horizontal Sliding Boards save wall space and add functional board surface.
- Lightweight core material and precise alignment of the tracks ensure easy operation. Choose from two-, three-, or four-track systems. Panels are 4'H and from 6' to 20'W. Available with porcelain steel markerboard or any tackable surface.
- Framed with heavy gauge anodized aluminum tubing. Map rail and accessory tray included.
- SCS Indoor Advantage Gold Certified.

PART NO.	DESCRIPTION	DIMS	WT.
PRODUCT			
822HH	2 Track / 2 Panel	4H x 8W	350 lbs
822HM	2 Track / 2 Panel	4H x 12W	510 lbs
824HH	4 Track / 4 Panel	4H x 8W	415 lbs
824HM	4 Track / 4 Panel	4H x 12W	620 lbs

[VIEW ONLINE](#)



HOW DO YOU FEEL?

 HAPPY	 SAD	 ANGRY	 HUNGRY	 EMBARRASSED
 SLEEPY	 UNSURE	 SICK	 PROUD	 LONELY
 JEALOUS	 SURPRISED	 ANNOYED	 SHY	 SCARED
 BORED	 NERVOUS	 EXCITED	 GUILTY	 SILLY



I feel sad
sometimes

II: Tackboards



Natural Cork Tackboard

- Natural cork is always a winning choice. Classic unfinished cork adds an organic element to any environment.
- Natural cork tackboards are suitable for any classroom, library, or other space, dampening sound and adding texture as well as display space.
- Natural cork is an environmentally responsible and naturally renewable resource. Cork is harvested from a cork tree, stripped with careful cuts that do not harm the inner core of the tree. The cork bark regrows, and this process allows a useful life of more than 150 years for each tree.
- Choose from three substrate options to fit your requirements or budget:
- **Valu-Tak:** Our most economical and best value surface, Valu-Tak features ¼" thick cork layer bonded to ⅝" lightweight and tackable substrate material.
- **Natural Add-Cork:** Step up to our select Add-Cork surface, which features a ⅜" thick cork layer bonded to ¾" thick durable substrate material.
- **Natural Cork-Plate:** Premium Cork-Plate surface is our top of the line option, featuring a full ½" thick cork layer bonded to ¾" thick rigid and moisture-resistant substrate material.
- Anodized aluminum trim has a ⅞" profile with hairline mitered corners. Black aluminum trim available at an upcharge.
- Ten year limited warranty. SCS Indoor Advantage Gold Certified.

PART NO.	DIMENSIONS	SHIP WT.
VALU-TAK		
301AA	1.5H x 2'W	3 lbs
301AB	2'H x 3'W	7 lbs
301AC	3'H x 4'W	13 lbs
301AD	4'H x 4'W	20 lbs
301AF	4'H x 5'W	28 lbs
301AG	4'H x 6'W	30 lbs
301AH	4'H x 8'W	38 lbs
301AK	4'H x 10'W	42 lbs
301AM	4'H x 12'W	47 lbs

PART NO.	DIMENSIONS	SHIP WT.
NATURAL ADD-CORK		
302AA	1.5H x 2'W	6 lbs
302AB	2'H x 3'W	12 lbs
302AC	3'H x 4'W	20 lbs
302AD	4'H x 4'W	39 lbs
302AF	4'H x 5'W	46 lbs
302AG	4'H x 6'W	49 lbs
302AH	4'H x 8'W	64 lbs
302AK	4'H x 10'W	71 lbs
302AM	4'H x 12'W	104 lbs

PART NO.	DIMENSIONS	SHIP WT.
NATURAL CORK-PLATE		
303AA	1.5H x 2'W	6 lbs
303AB	2'H x 3'W	14 lbs
303AC	3'H x 4'W	22 lbs
303AD	4'H x 4'W	44 lbs
303AF	4'H x 5'W	55 lbs
303AG	4'H x 6'W	66 lbs
303AH	4'H x 8'W	88 lbs

[VIEW ONLINE](#)

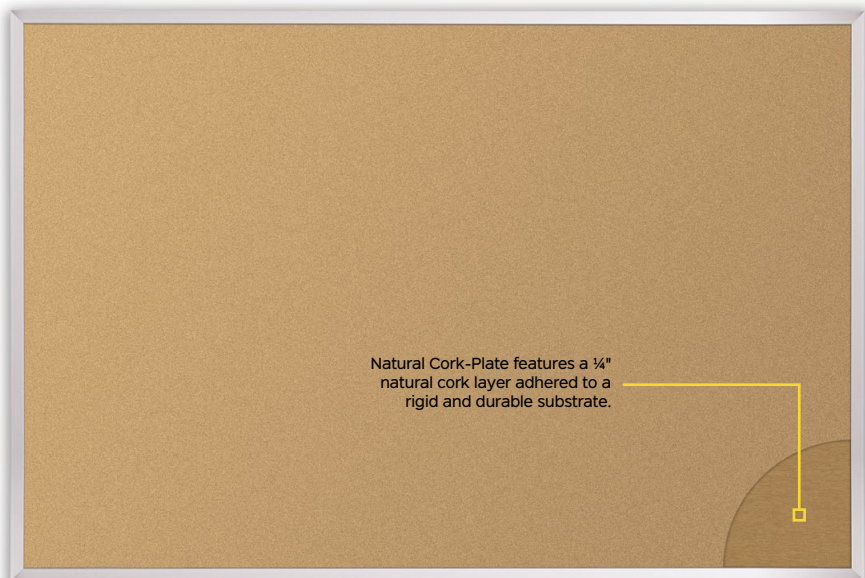
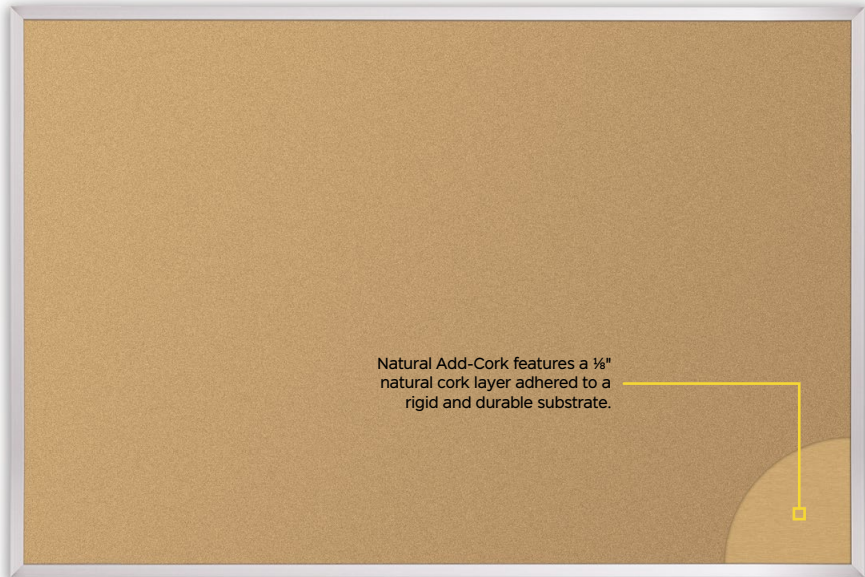

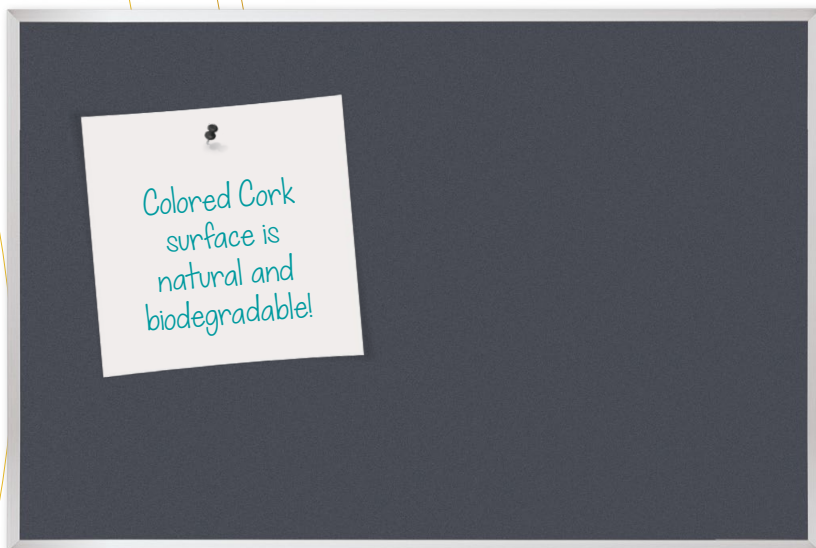

Colored Cork Tackboard

- Colored Cork Tackboards feature colorful and durable Forbo® linoleum, produced from natural and renewable raw materials.
- Featured with standard 3/8" clear anodized aluminum trim with hairline mitered corners.
- Ten year limited warranty. SCS Indoor Advantage Gold Certified.

PART NO.	DIMENSIONS	SHIP WT.
PRODUCT		
322AA	1.5H x 2W	6 lbs
322AB	2H x 3W	14 lbs
322AC	3H x 4W	22 lbs
322AD	4H x 4W	44 lbs
322AF	4H x 5W	55 lbs
322AG	4H x 6W	66 lbs
322AH	4H x 8W	88 lbs

[VIEW ONLINE](#)

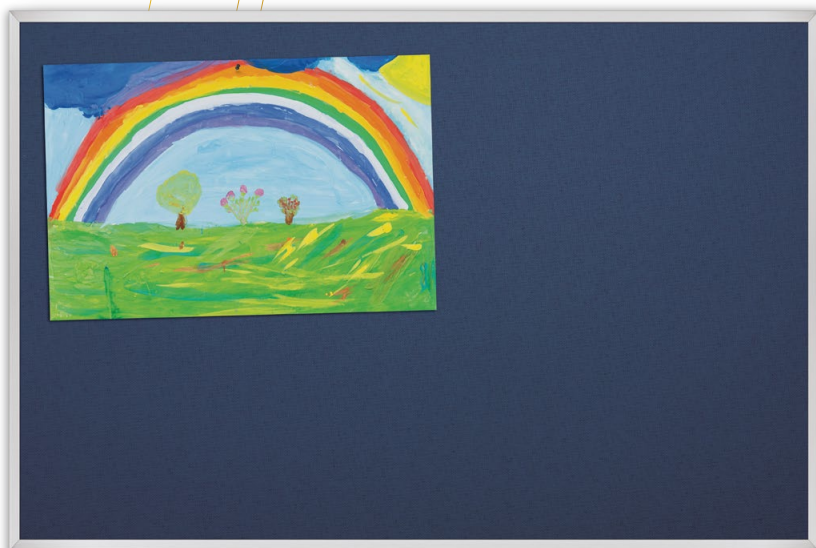

Fabric Tackboard

- Durable and non-fraying fabric creates an attractive tackboard suitable for any classroom, library, or other space, dampening sound and adding texture as well as display space.
- Polyolefin fabric is washable, and unaffected by most common household chemicals, salts, and cleansers. Fabric is also treated to resist the growth of stain- and odor-causing microbes.
- **Fab-Tak:** Our most economical and best value surface, Fab-Tak features fabric adhered to 3/8" lightweight and tackable substrate material.
- **Fabric Add-Cork:** Step up to our select Add-Cork surface, which features fabric adhered to a 1/8" thick cork layer bonded to 3/8" thick durable substrate material.
- **Fabric Cork-Plate:** Premium Cork-Plate surface is our top of the line option, featuring fabric adhered to a full 1/4" thick cork layer bonded to 3/8" thick rigid and moisture-resistant substrate material.
- Featured with standard 3/8" clear anodized aluminum trim with hairline mitered corners. Anodized black aluminum trim available at an upcharge.
- Ten year limited warranty on all surfaces. SCS Indoor Advantage Gold Certified.

[VIEW ONLINE](#)

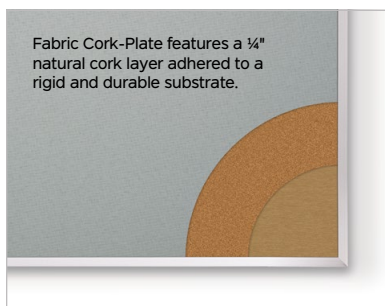
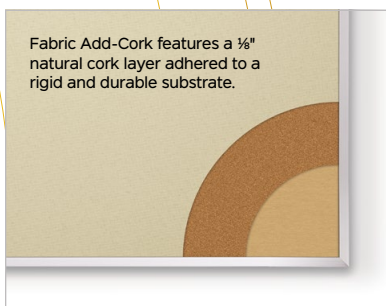

PART NO.	DIMENSIONS	SHIP WT.
FAB-TAK		
331AA	1.5H x 2W	3 lbs
331AB	2H x 3W	7 lbs
331AC	3H x 4W	13 lbs
331AD	4H x 4W	20 lbs
331AF	4H x 5W	28 lbs
331AG	4H x 6W	30 lbs
331AH	4H x 8W	38 lbs
331AK	4H x 10W	42 lbs
331AM	4H x 12W	47 lbs

PART NO.	DIMENSIONS	SHIP WT.
FABRIC ADD-CORK		
332AA	1.5H x 2W	6 lbs
332AB	2H x 3W	12 lbs
332AC	3H x 4W	20 lbs
332AD	4H x 4W	39 lbs
332AF	4H x 5W	46 lbs
332AG	4H x 6W	49 lbs
332AH	4H x 8W	64 lbs
332AK	4H x 10W	71 lbs
332AM	4H x 12W	104 lbs

PART NO.	DIMENSIONS	SHIP WT.
FABRIC CORK-PLATE		
333AA	1.5H x 2W	6 lbs
333AB	2H x 3W	14 lbs
333AC	3H x 4W	22 lbs
333AD	4H x 4W	44 lbs
333AF	4H x 5W	55 lbs
333AG	4H x 6W	66 lbs
333AH	4H x 8W	88 lbs

TACKBOARDS: Vinyl / Display Rails & Panels

Vinyl Tackboard

- Fabric-backed vinyl over a tackable substrate makes a low-maintenance and attractive tackboard. An easy to clean surface, the vinyl is treated to resist the growth of odor- and stain-causing microbes.
- Choose from three substrate options to fit your requirements or budget:
- Vin-Tak:** Our most economical and best value surface, Vin-Tak features vinyl adhered to 7/16" lightweight and tackable substrate material.
- Vinyl Add-Cork:** Step up to our select Add-Cork surface, which features vinyl adhered to a 1/8" thick cork layer bonded to 3/8" thick durable substrate material.
- Vinyl Cork-Plate:** Premium Cork-Plate surface is our top of the line option, featuring vinyl adhered to a full 1/4" thick cork layer bonded to 1/4" thick rigid and moisture-resistant substrate material.
- Featured with standard 7/8" clear anodized aluminum trim with hairline mitered corners. Anodized black aluminum trim available at an upcharge.
- Ten year limited warranty. SCS Indoor Advantage Gold Certified.

VIEW ONLINE

PART NO.	DIMENSIONS	SHIP WT.
VIN-TAK		
311AA	1.5H x 2W	3 lbs
311AB	2H x 3W	7 lbs
311AC	3H x 4W	13 lbs
311AD	4H x 4W	20 lbs
311AF	4H x 5W	28 lbs
311AG	4H x 6W	30 lbs
311AH	4H x 8W	38 lbs
311AK	4H x 10W	42 lbs
311AM	4H x 12W	47 lbs

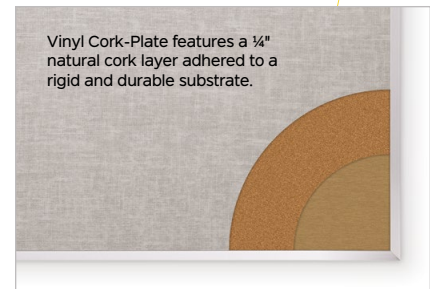
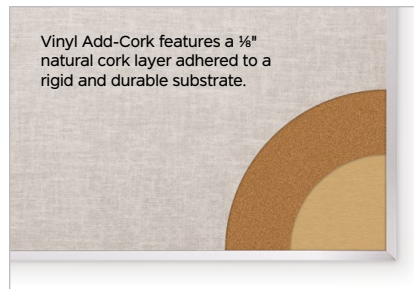
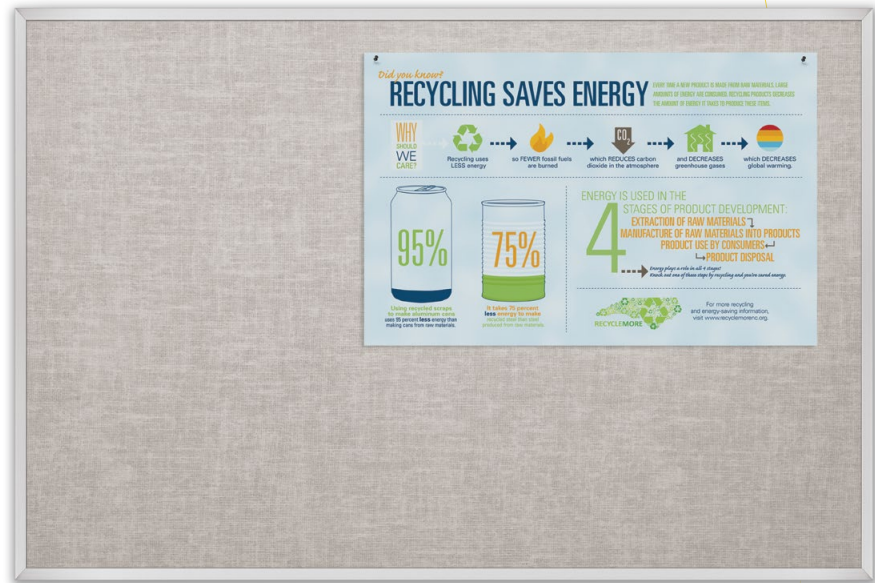

PART NO.	DIMENSIONS	SHIP WT.
VINYL ADD-CORK		
312AA	1.5H x 2W	6 lbs
312AB	2H x 3W	12 lbs
312AC	3H x 4W	20 lbs
312AD	4H x 4W	39 lbs
312AF	4H x 5W	46 lbs
312AG	4H x 6W	49 lbs
312AH	4H x 8W	64 lbs
312AK	4H x 10W	71 lbs
312AM	4H x 12W	104 lbs

PART NO.	DIMENSIONS	SHIP WT.
VINYL CORK-PLATE		
313AA	1.5H x 2W	6 lbs
313AB	2H x 3W	14 lbs
313AC	3H x 4W	22 lbs
313AD	4H x 4W	44 lbs
313AF	4H x 5W	55 lbs
313AG	4H x 6W	66 lbs
313AH	4H x 8W	88 lbs



Tack-Bite

- Features a unique roller system to provide a secure hold and quick release. Natural cork tackable insert for even more versatility.
- Optional accessories available. Sold in sets of six except for 96" sold in set of four.
- Ten year limited warranty. SCS Indoor Advantage Gold Certified.

PART NO.	DIMENSIONS	SHIP WT.
PRODUCT		
504-0	2.5H x 7W	2 lbs
504-1	2.5H x 12W	4 lbs
504-2	2.5H x 24W	5 lbs
504-3	2.5H x 36W	7 lbs
504-4	2.5H x 48W	10 lbs
504-6	2.5H x 72W	12 lbs
504-8	2.5H x 96W	13 lbs

VIEW ONLINE

Bulletin Bar

- Turn any unused wall space into an instant display area with tackable bulletin bars. Ideal for classrooms, offices, design spaces, libraries, and other collaborative environments.
- Bulletin bars consist of a tackable natural cork strip encased in a 1" satin aluminum extrusion.
- Available in a variety of lengths, bars are sold in packages of 12 with a set of 40 push pins.
- SCS Indoor Advantage Gold Certified.

PART NO.	DIMENSIONS	SHIP WT.
PRODUCT		
558-1	1H x 12W	3 lbs
558-2	1H x 24W	5 lbs
558-3	1H x 36W	8 lbs
558-4	1H x 48W	10 lbs

VIEW ONLINE





Map Rail

- Durable map rails turn any empty wall space into instant display space.
- Map rails are available in 1" or 2" high varieties, with a colored cork tackable insert. Extrusion is anodized aluminum.
- Sold in sets of six. Hook clips, flag holders, map winders, and end stops available separately.
- SCS Indoor Advantage Gold Certified.

PART NO.	DIMENSIONS	SHIP WT.
1" MAP RAILS (SET OF 6)		
522D-07	1"H x 4"W	6 lbs
522G-07	1"H x 6"W	8 lbs
522H-07	1"H x 8"W	10 lbs
522K-07	1"H x 10"W	14 lbs
522M-07	1"H x 12"W	18 lbs
1" MAP RAIL ACCESSORIES		
510	Hook Clip	1 lb
512	Flag Holder	1 lb
514	Map Winders (2)	1 lb
516	End Stops (2)	1 lb
2" MAP RAILS (SET OF 6)		
523D-07	2"H x 4"W	8 lbs
523G-07	2"H x 6"W	14 lbs
523H-07	2"H x 8"W	18 lbs
523K-07	2"H x 10"W	22 lbs
523M-07	2"H x 12"W	33 lbs
2" MAP RAIL ACCESSORIES		
511	Hook Clip	1 lb
513	Flag Holder	1 lb
515	Map Winders (2)	1 lb
517	End Stops (2)	1 lb

[VIEW ONLINE](#)

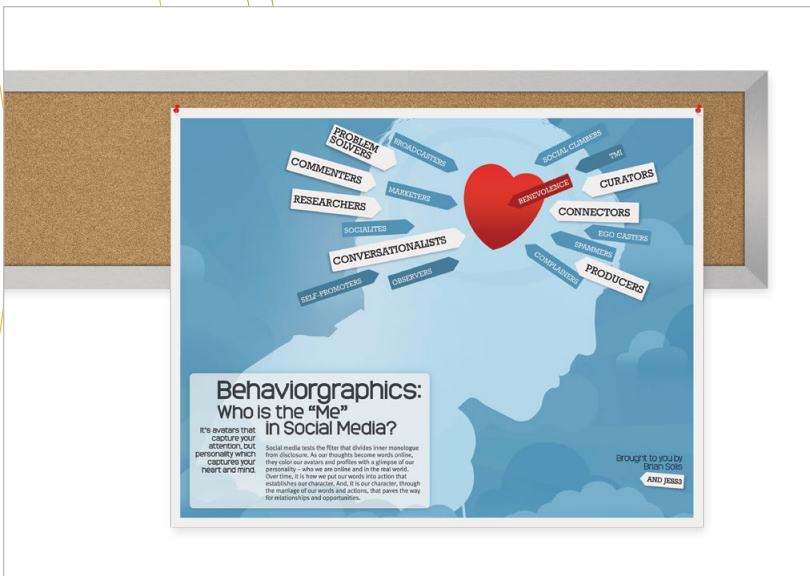

Tackboard Display Panel

- Tackboard Display Panels turn any blank wall into instant display space. Ideal for hanging artwork, posters, maps, or other information.
- Twelve-inch high panels provide ample tack space without taking up the space of a full-size tackboard. Choose the size and material that fits your space the best.
- Available in natural cork or in easy to clean vinyl over a lightweight substrate.
- Ten year limited warranty. SCS Indoor Advantage Gold Certified.

PART NO.	DIMENSIONS	SHIP WT.
PRODUCT		
507AG	11.8"H x 72"W	12 lbs
507AH	11.8"H x 96"W	16 lbs

[VIEW ONLINE](#)



III: Mobile Boards & Easels



MOBILE BOARDS & EASELS: Mobile Glass Boards

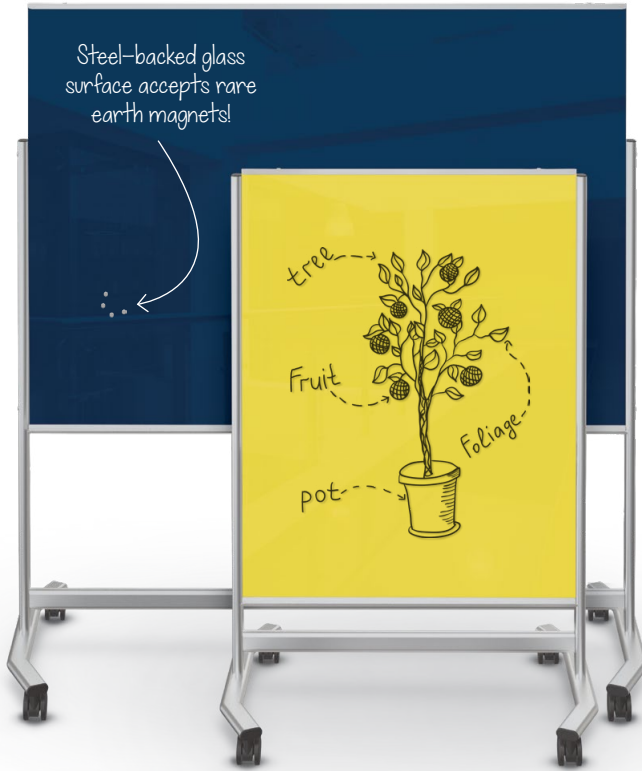

Visionary® Move Mobile Glass Board

- Get your ideas on the go—in full color. Mobile glass board moves your info with you wherever you need it.
- Ultra durable double-sided glass magnetic markerboard is a contemporary communication tool providing the highest quality writing and erasing experience. Accepts rare earth magnets.
- Smooth finish accepts dry erase, wet erase, chalk markers and more. Tempered safety glass for use in any environment with sturdy steel plate backing.
- Choose from any of our standard glass colors—even mix and match sides for a designer board. Custom colors and graphic printing available.
- Frame and trim are made with platinum powder-coated steel for superior durability.
- Wide base design for stability includes dual-wheel locking casters. Mobile board can be set at either 60-½"H or 72-¾"H for ideal viewing.
- SCS Indoor Advantage Gold Certified.

[VIEW ONLINE](#)

PART NO. PRODUCT	DESCRIPTION	DIMENSIONS	SHIP WT.
74950-XXXX	Visionary Move (Small)	72.8"H x 38.3"W x 25.9"D	156 lbs
74951-XXXX	Visionary Move (Large)	72.8"H x 73.1"W x 25.9"D	360 lbs



Visionary® Curve Colors Mobile Glass Board

- Get up to twice the functional space of a wall-mounted board with a versatile and stylish Visionary Curve Colors mobile magnetic glass board, with a modern white frame and colored glass options.
- Panel is beautiful and modern double-sided magnetic glass, giving you style as well as a surface that provides unmatched writability and erases without ghosting.
- Glass available in multiple colors. Choose the color that will accent the design of your environment. Mix and match for an even more personalized board. Custom colors and graphics available.
- Tempered safety glass surface measures 47-¼"H x 35-½"W and accepts rare earth magnets.
- Frame and trim are made with white powder-coated steel for superior durability. Wide base design for stability includes dual-wheel locking casters.
- SCS Indoor Advantage Gold Certified.

[VIEW ONLINE](#)

PART NO. PRODUCT	DESCRIPTION	DIMENSIONS	SHIP WT.
74957-XXXX	Visionary Curve Colors	68.8"H x 36"W x 22.8"D	144 lbs



Hierarchy Grow & Roll Mobile Glass Board

- A colorful board that accommodates all ages. Floor length board is easy to use and works as a space divider as well.
- Ideal for use in collaborative learning environments, the dual-sided magnetic glass markerboard allows for multiple users, while the floor to stand surface maximizes use.
- Available in two sizes. Moves easily wherever you want it.
- Available in all Hierarchy colors and custom colors as well. Mix and match front and back surface for a designer appearance.
- Standard with a platinum frame and dual-wheel swivel casters (two locking).
- SCS Indoor Advantage Gold Certified.

PART NO.	DESCRIPTION	DIMENSIONS	SHIP WT.
84425	Small	47.2"H x 35.4"W x 23.5"D	150 lbs
84426	Large	70.9"H x 47.2"W x 23.5"D	350 lbs

[VIEW ONLINE](#)

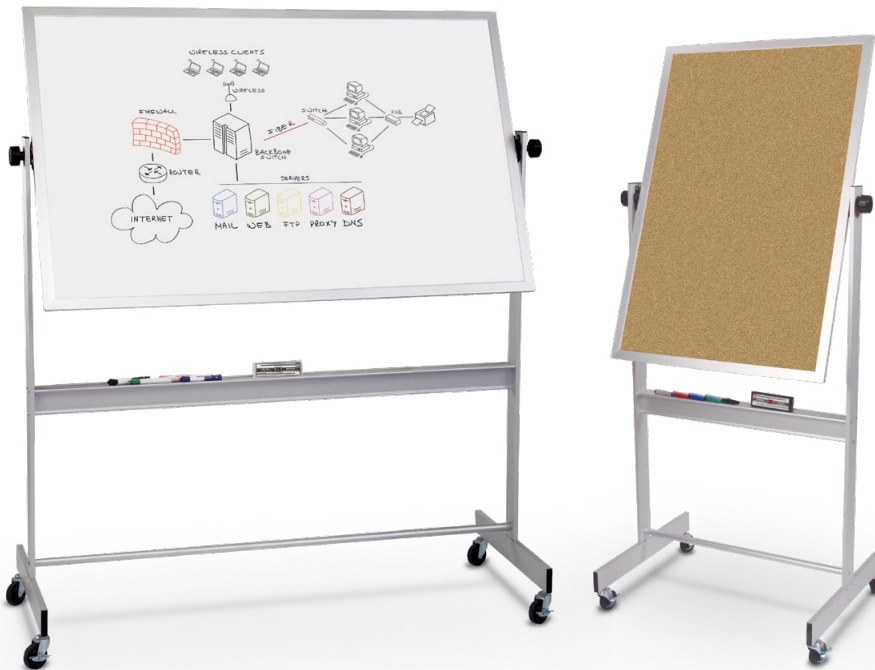
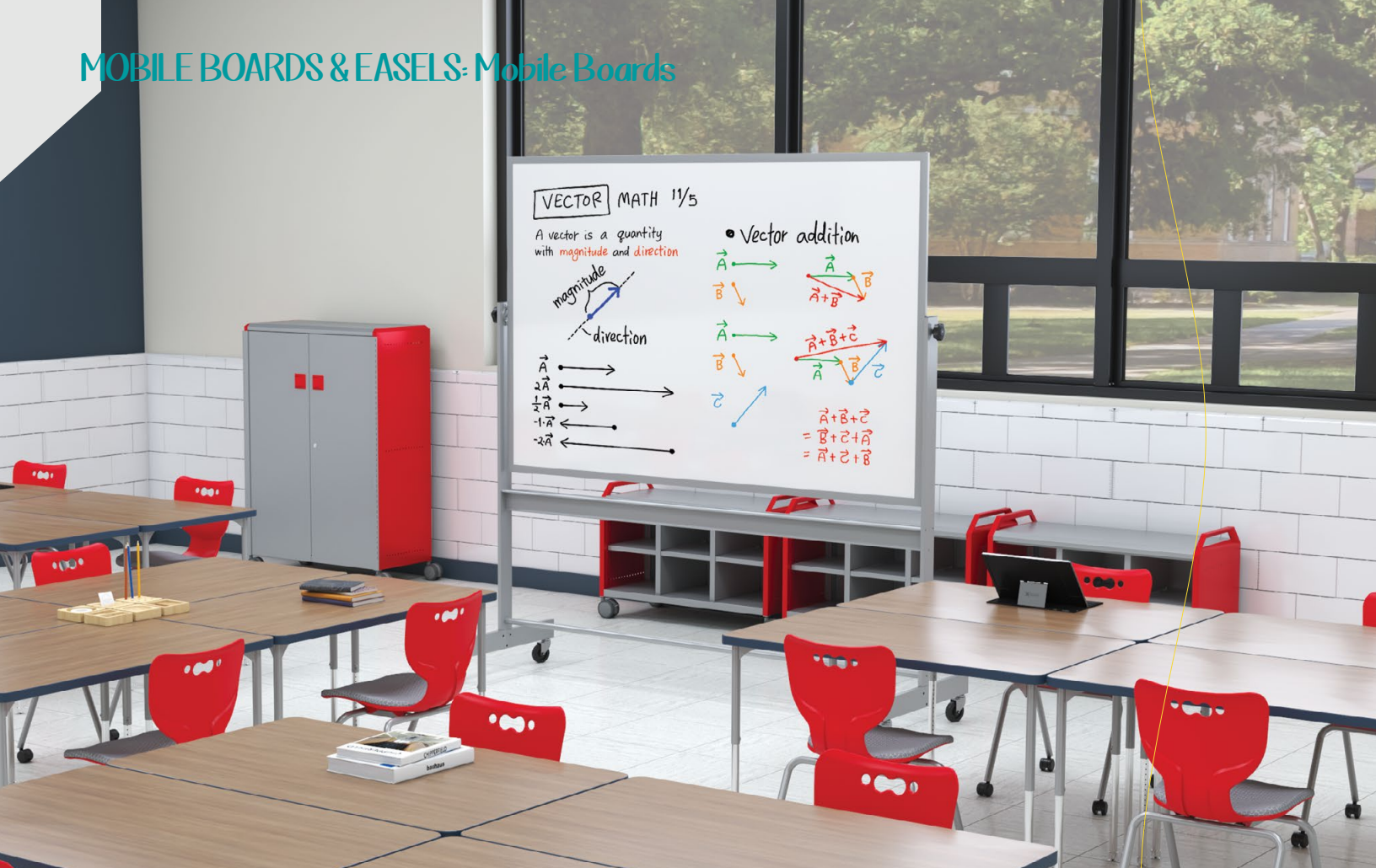

Deluxe Mobile Reversible Board

- Versatility on the move. Mobile boards offer up to twice as much functional space as a regular board.
- Get up to twice the functional space of a wall-mounted board with a versatile and mobile Deluxe Mobile Reversible Board.
- Boards are double-sided and available in a variety of surface combinations, including porcelain steel magnetic markerboard, Dura-Rite HPL dry erase markerboard, and tackable natural cork.
- Panel rotates 360° on a pivot hinge, and locks into place with the turn of a knob.
- Available with a panel size of 40”H x 30”W, 4’H x 5’W, 4’H x 6’W, or 4’H x 8’W. Smallest size ships UPS to save you time and money.
- Anodized aluminum trim includes a full-length accessory tray. Wide base design for stability includes 3” locking casters.
- SCS Indoor Advantage Gold Certified.

[VIEW ONLINE](#)

PART NO.	SURFACE	DIMENSIONS	SHIP WT.
40”H X 30”W PANEL			
668AC-DD	Porcelain Steel Whiteboard	40”H x 30”W	60 lbs
668AC-DC	Porcelain Steel Whiteboard / Natural Cork	40”H x 30”W	75 lbs
4’H X 5’W PANEL			
668AF-DD	Porcelain Steel Whiteboard	4’H x 5’W	116 lbs
668AF-DC	Porcelain Steel Whiteboard / Natural Cork	4’H x 5’W	105 lbs

PART NO.	SURFACE	DIMENSIONS	SHIP WT.
4’H X 6’W PANEL			
668AG-DD	Porcelain Steel Whiteboard	4’H x 6’W	130 lbs
668AG-DC	Porcelain Steel Whiteboard / Natural Cork	4’H x 6’W	114 lbs
4’H X 8’W PANEL			
668AH-DD	Porcelain Steel Whiteboard	4’H x 8’W	170 lbs
668AH-DC	Porcelain Steel Whiteboard / Natural Cork	4’H x 8’W	114 lbs



Platinum Mobile Reversible Board

- Upscale appearance with all the functionality you expect. Attractive and modern mobile reversible adds style to any space.
- Panel is trimmed with modern anodized aluminum, rotates 360° on a pivot hinge, and locks into place with the turn of a knob. Trim includes a full-length accessory tray with perforated panel for style and stability. Wide base design for stability includes molded bumpers to protect walls, and 3" locking casters.
- SCS Indoor Advantage Gold Certified.

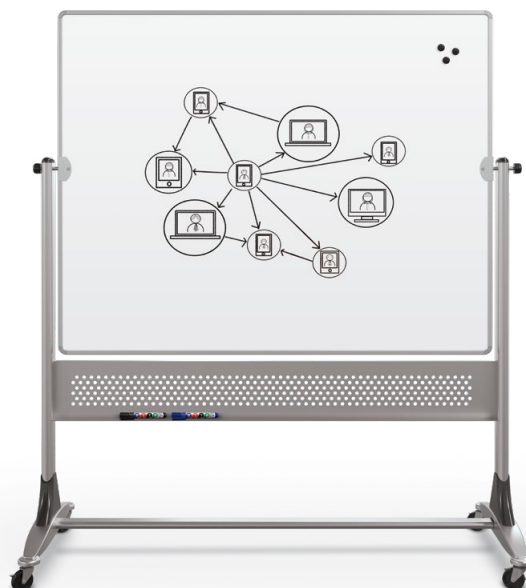

PART NO.	SURFACE	DIMENSIONS	SHIP WT.
PRODUCT			
669RU-DD	Porcelain Steel Whiteboard	40"H x 30"W	66 lbs
669RU-DC	Porcelain Steel Whiteboard / Natural Cork	40"H x 30"W	72 lbs
669RF-DD	Porcelain Steel Whiteboard	4'H x 5'W	135 lbs
669RF-DC	Porcelain Steel Whiteboard / Natural Cork	4'H x 5'W	143 lbs
669RG-DD	Porcelain Steel Whiteboard	4'H x 6'W	134 lbs
669RG-DC	Porcelain Steel Whiteboard / Natural Cork	4'H x 6'W	147 lbs
669RH-DD	Porcelain Steel Whiteboard	4'H x 8'W	209 lbs
669RH-DC	Porcelain Steel Whiteboard / Natural Cork	4'H x 8'W	191 lbs

[VIEW ONLINE](#)

Ogee Curved Easel

- Throw a curve on the standard easel! Smoothly sloped surface allows full use for all ages and sizes.
- The curved whiteboard surface on the Ogee Curved Easel maximizes the use of the writing surface while giving it a sleek high end design look.
- Durable porcelain steel surface measures 72"H x 36"W. Curved bottom makes writing on the lower portion of the board easier.
- Middle storage tray also functions as a handle to easily move the Ogee around wherever it's needed.
- Great for space division. Boards nest using the handle.
- Comes standard with a marker tray, and bottom shelf provides additional storage space.
- SCS Indoor Advantage Gold Certified.

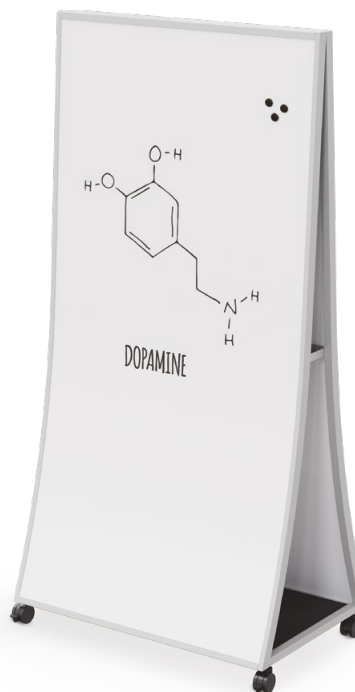

PART NO.	DESCRIPTION	DIMENSIONS	SHIP WT.
PRODUCT			
55471-DD	Ogee Curved Easel (Porcelain Steel)	74.3"H x 36.5"W x 23.5"D	107 lbs

[VIEW ONLINE](#)

MOBILE BOARDS & EASELS: Mobile Boards & Room Dividers



D.O.C. Mobile Room Divider

- Divide and conquer your space. Create the spaces and divisions you need with these easy to use mobile panels.
- Versatile and multi-functional, D.O.C. Mobile Room Dividers allow you to divide, organize, and customize a work or display area however you choose.
- Mobile double-sided dividers come in a variety of surface combinations, including porcelain steel magnetic whiteboard, Dura-Rite HPL whiteboard, natural cork, and decorative laminate.
- Three sizes available for maximum configuration flexibility: 6'H x 4'W, 6'H x 6'W, and 6'H x 8'W.
- Panels are trimmed in modern anodized aluminum and include locking casters.
- Leg design minimizes gapping, and connectors are available to join panels at 90° or 180° angles.
- SCS Indoor Advantage Gold Certified.

[VIEW ONLINE](#)

PART NO. PRODUCT	SURFACE	PANEL SIZE	OVERALL DIMENSIONS	SHIP WT.
661AD-DD	Porcelain Steel	58"H x 46.3"W	73"H x 52"W x 20"D	120 lbs
661AG-DD	Porcelain Steel	58"H x 70.3"W	73"H x 76"W x 20"D	180 lbs
661AH-DD	Porcelain Steel	58"H x 94.5"W	73"H x 100"W x 20"D	220 lbs

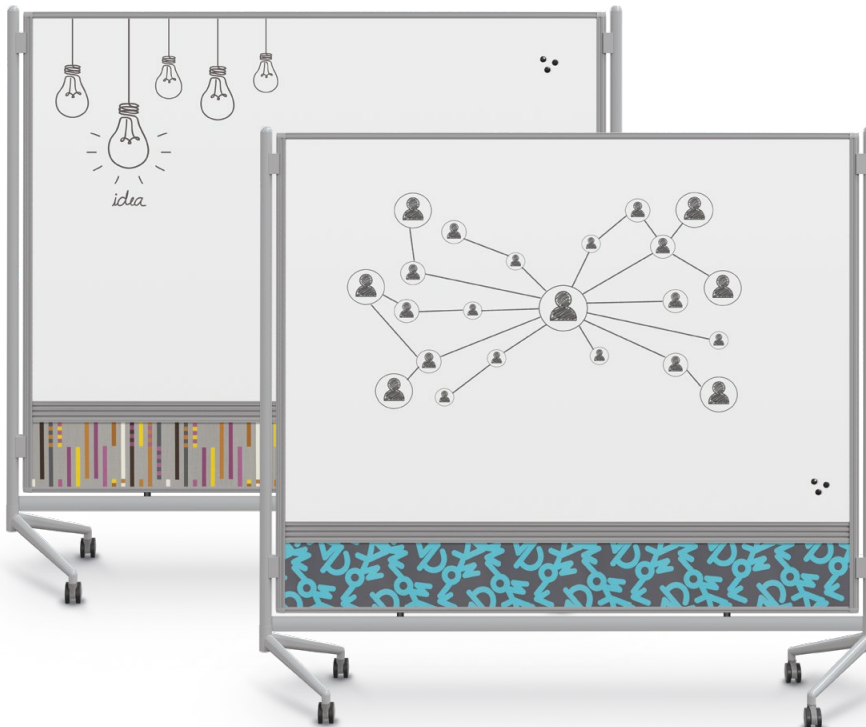

D.O.C. Mobile Room Divider - Custom Fabric Panel

- Divide and conquer with style. Get all of the functionality of a D.O.C. with a sophisticated and customizable fabric panel upgrade.
- Available with a customizable fabric panel to match your soft seating or any other environment, versatile and multi-functional D.O.C. Mobile Room Dividers allow you to divide, organize, and customize a work or display area however you choose.
- Three sizes available for maximum configuration flexibility: 6'H x 4'W, 6'H x 6'W, and 6'H x 8'W.
- Upgrade your D.O.C. and add color and texture to your spaces with a sophisticated and customizable fabric panel upgrade. Choose a fabric from our graded-in program (COM available on approval) and enjoy a completely unique and designer room divider.
- Leg design minimizes gapping, and connectors are available to join panels at 90° or 180° angles. Base includes locking casters.
- SCS Indoor Advantage Gold Certified.

[VIEW ONLINE](#)

PART NO. PRODUCT	SURFACE	PANEL SIZE	OVERALL DIMENSIONS	SHIP WT.
661AD-DD-XXXX	Porcelain Steel	6'H x 4'W	73"H x 52"W x 20"D	120 lbs
661AG-DD-XXXX	Porcelain Steel	6'H x 6'W	73"H x 76"W x 20"D	180 lbs
661AH-DD-XXXX	Porcelain Steel	6'H x 8'W	73"H x 100"W x 20"D	220 lbs



Divvy D.O.C. Mobile Room Divider

- Divide, organize, customize, and now modernize. With ultra stylish multi-panel Divvy D.O.C. room dividers, you can add instant color and texture (and functional whiteboard) to any space, in a truly unique ready-to-roll room divider.
- Mobile double-sided dividers include a variety of attractive and colorful surfaces to add style and function to any environment, while also offering privacy, acoustic shielding, and easy configuration.
- Available in two standard configurations. Sized at 6'H x 6'W for maximum configuration flexibility. Panel measures 58"H x 70-1/4"W.
- Your options for a custom Divvy D.O.C. are virtually limitless: choose from fabric, laminate, whiteboard, or tackboard surfaces. Go completely custom and get our design team to help create an amazing divider just for you!
- SCS Indoor Advantage Gold Certified.

[VIEW ONLINE](#)

PART NO.	DESCRIPTION	PANEL SIZE	OVERALL DIMENSIONS	SHIP WT.
PRODUCT				
661DG-L2	Standard	58"H x 70.3"W	73"H x 76"W x 20"D	160 lbs
661DG-L3	Balanced	58"H x 70.3"W	73"H x 76"W x 20"D	160 lbs
661DG-CUSTOM	Custom	58"H x 70.3"W	73"H x 76"W x 20"D	160 lbs



D.O.C. Glass Mobile Room Divider

- Fresh modern style enhances creativity in your work environment. Pairing elegant magnetic glass whiteboard with a mobile aluminum frame, D.O.C. Glass Mobile Room Dividers allow you the freedom to divide, organize, and customize your space to fit your individual needs.
- Modular panels move wherever needed to create whatever space is needed; locking swivel casters keep them in place. Two sizes available for maximum configuration flexibility: 6'H x 4'W or 6'H x 6'W
- Double-sided in tempered safety glass to provide smooth writability and erasability. Glass is backed with steel to accept rare earth magnets.
- Divider comes standard with gloss white glass, but you can customize the glass panel in a variety of ways to personalize your workspace, including color and graphic printing options.
- Decorative kickplate is finished in your choice of laminates. Choose a standard option or create a custom divider.
- SCS Indoor Advantage Gold Certified.

[VIEW ONLINE](#)

PART NO.	DESCRIPTION	PANEL SIZE	OVERALL DIMENSIONS	SHIP WT.
PRODUCT				
8201D-XXXX	Silver Frame + White Glass	6'H x 4'W	73"H x 52"W x 20"D	360 lbs
8201G-XXXX	Silver Frame + White Glass	6'H x 6'W	73"H x 75.4"W x 20"D	540 lbs

MOBILE BOARDS & EASELS: Easels

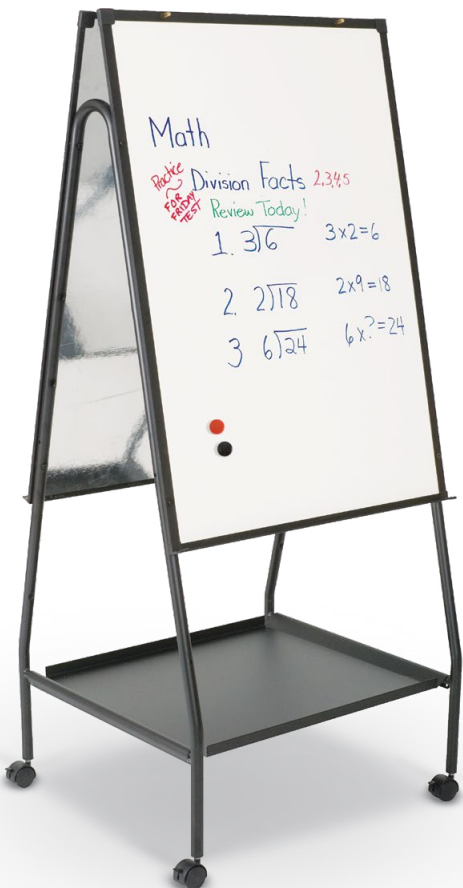
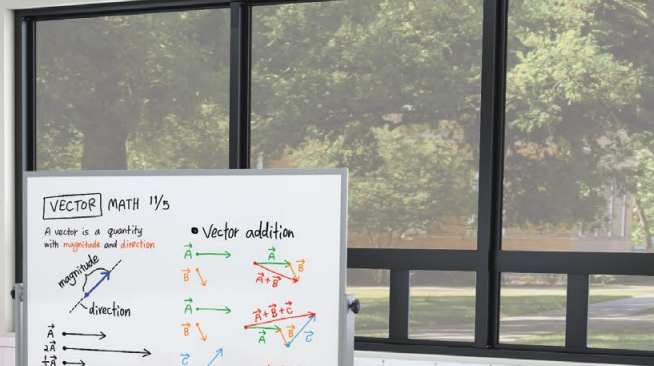
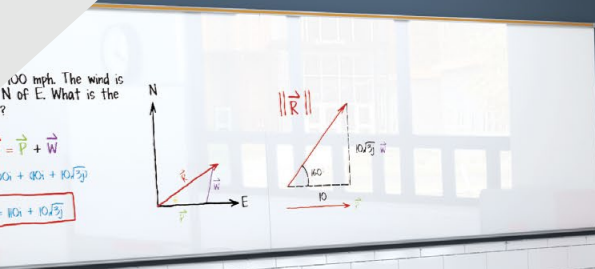

Wheasel® Mobile Easel

- The Wheasel is a versatile double-sided mobile easel ideal for any environment. Available framed with a magnetic porcelain steel whiteboard surface, or unframed with a melamine whiteboard surface.
- Lower storage tray and locking 2" casters included. Accessory tray and flip chart hooks on each side.
- SCS Indoor Advantage Gold Certified.

PART NO.	DESCRIPTION	DIMENSIONS	SHIP WT.
770	Porcelain Steel	65"H x 28.8"W x 27"D	55 lbs
759	Melamine	65"H x 28.8"W x 27"D	45 lbs

[VIEW ONLINE](#)



Nest Easel

- The Nest Easel is designed to nest together for compact storage. Includes double-sided magnetic whiteboard.
- Features accessory trays and flip chart hooks and height adjustable storage box. Can be adjusted to 65" or 72" high. Base includes 2" casters.
- SCS Indoor Advantage Gold Certified.

PART	DESC.	DIMENSIONS	WT.
PRODUCT			
785P	Silver	72"H x 34.8"W x 24"D	69 lbs

[VIEW ONLINE](#)



Preschool Divider

- Preschool Dividers are the ideal portable panel and room divider for any early childhood environment.
- Use the versatile Preschool Dividers as room dividers, acoustical shields, storyboard displays, or to exhibit artwork. Join dividers together to create private learning areas, or to divide rooms into activity areas.
- Available finished in easy to clean vinyl, or melamine dry erase surface in black anodized aluminum trim. Lightweight panel and wide base design create stability.
- Panels include 2" casters (two locking). Each panel is 18"D.
- SCS Indoor Advantage Gold Certified.

[VIEW ONLINE](#)

PART NO.	DIMENSIONS	SHIP WT.
VINYL / VINYL		
646D	4H x 4W x 18"D	37 lbs
646F	4H x 5W x 18"D	42 lbs
646G	4H x 6W x 18"D	48 lbs

PART NO.	DIMENSIONS	SHIP WT.
WHITEBOARD / VINYL		
648D	4H x 4W x 18"D	37 lbs
648F	4H x 5W x 18"D	42 lbs
648G	4H x 6W x 18"D	48 lbs

PART NO.	DIMENSIONS	SHIP WT.
WHITEBOARD / WHITEBOARD		
650D	4H x 4W x 18"D	37 lbs
650F	4H x 5W x 18"D	42 lbs
650G	4H x 6W x 18"D	48 lbs

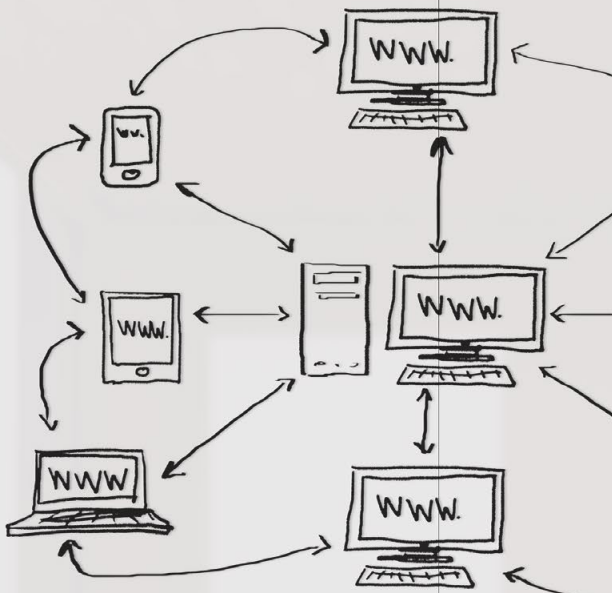

IV: Wall Systems & Resurfacing



WALL SYSTEMS & RESURFACING: Glass Wall Systems



Report Basic Glass Wall System

- Report will modernize and elevate your walls instantly with smart style and functional whiteboard space, ideal for communication, collaboration, and creativity. Create a user-friendly and inviting room-sized presentation surface.
- Tempered safety glass is suited for use in any environment, from industrial to classroom and everything in between. Steel-backed glass accepts rare earth magnets.
- Glass is available standard in gloss white, or in any of our standard glass colors. Create one sleek monochrome wall, or mix and match for a designer appearance. Custom colors and graphics also available.
- The Report Basic Series features stainless steel mounting standoffs along the top edge, and a full-length anodized aluminum accessory tray along the bottom for storing markers and erasers.
- Fifty year limited warranty. SCS Indoor Advantage Gold Certified.

PART NO.	DIMENSIONS	SHIP WT.
PRODUCT		
GWA406-XXXX	4H x 6W	79 lbs
GWA408-XXXX	4H x 8W	104 lbs
GWA412-XXXX	4H x 12W	170 lbs
GWA416-XXXX	4H x 16W	224 lbs

[VIEW ONLINE](#)

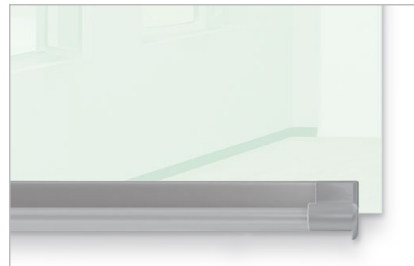
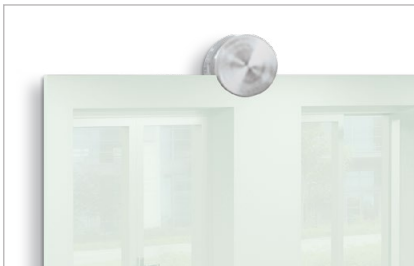

Unity Commercial Glass Wall System

- Unity will modernize and elevate your walls instantly with smart style and functional whiteboard space, ideal for communication, collaboration, and creativity. Create a user-friendly room-sized presentation surface.
- Tempered safety glass is suited for use in any environment. Steel-backed glass accepts rare earth magnets. Glass is gloss white, or available in any standard or custom color.
- The Unity Commercial Series features slim and modern aluminum trim along the top and bottom edge.
- Fifty year limited warranty. SCS Indoor Advantage Gold Certified.

PART NO.	DIMENSIONS	SHIP WT.
PRODUCT		
GWD406-XXXX	4H x 6W	79 lbs
GWD408-XXXX	4H x 8W	104 lbs
GWD412-XXXX	4H x 12W	170 lbs
GWD416-XXXX	4H x 16W	224 lbs
GWD608-XXXX	6H x 8W	166 lbs
GWD612-XXXX	6H x 12W	249 lbs
GWD616-XXXX	6H x 16W	332 lbs
GWD620-XXXX	6H x 20W	415 lbs
GWD624-XXXX	6H x 24W	498 lbs
GWD808-XXXX	8H x 8W	216 lbs
GWD812-XXXX	8H x 12W	324 lbs
GWD816-XXXX	8H x 16W	432 lbs
GWD820-XXXX	8H x 20W	540 lbs
GWD824-XXXX	8H x 24W	648 lbs

[VIEW ONLINE](#)



Liso Classroom Glass Wall System

- Liso will modernize and elevate your walls instantly with smart style and functional whiteboard space, ideal for communication, collaboration, and creativity. Create a user-friendly and inviting room-sized presentation surface.
- Tempered safety glass is suited for use in any environment, from industrial to classroom and everything in between. Steel-backed glass accepts rare earth magnets.
- Glass is available standard in gloss white, or in any of our standard glass colors. Create one sleek monochrome wall, or mix and match for a designer appearance. Custom colors and graphics also available.
- The Liso Classroom Series features a full-length tackable map rail along the top edge, and a full-length anodized aluminum accessory tray along the bottom for storing markers and erasers.
- Fifty year limited warranty. SCS Indoor Advantage Gold Certified.



PART NO.	DIMENSIONS	SHIP WT.
PRODUCT		
GWB406-XXXX	4H x 6W	79 lbs
GWB408-XXXX	4H x 8W	104 lbs
GWB412-XXXX	4H x 12W	170 lbs
GWB416-XXXX	4H x 16W	224 lbs

[VIEW ONLINE](#)



Fluent Office Glass Wall System

- Fluent will modernize and elevate your walls instantly with smart style and functional whiteboard space, ideal for communication, collaboration, and creativity.
- Tempered safety glass is suited for use in any environment. Steel-backed glass accepts rare earth magnets.
- The Fluent Office Series features slim anodized aluminum trim along the top, and a full-length anodized aluminum accessory tray along the bottom.
- Fifty year limited warranty. SCS Indoor Advantage Gold Certified.



PART NO.	DIMENSIONS	SHIP WT.
PRODUCT		
GWC406-XXXX	4H x 6W	79 lbs
GWC408-XXXX	4H x 8W	104 lbs
GWC412-XXXX	4H x 12W	170 lbs
GWC416-XXXX	4H x 16W	224 lbs
GWC608-XXXX	6H x 8W	166 lbs
GWC612-XXXX	6H x 12W	249 lbs
GWC616-XXXX	6H x 16W	332 lbs
GWC620-XXXX	6H x 20W	415 lbs
GWC624-XXXX	6H x 24W	498 lbs
GWC808-XXXX	8H x 8W	216 lbs
GWC812-XXXX	8H x 12W	324 lbs
GWC816-XXXX	8H x 16W	432 lbs
GWC820-XXXX	8H x 20W	540 lbs
GWC824-XXXX	8H x 24W	648 lbs

[VIEW ONLINE](#)

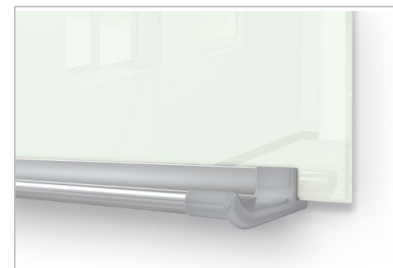

WALL SYSTEMS & RESURFACING: Porcelain Steel

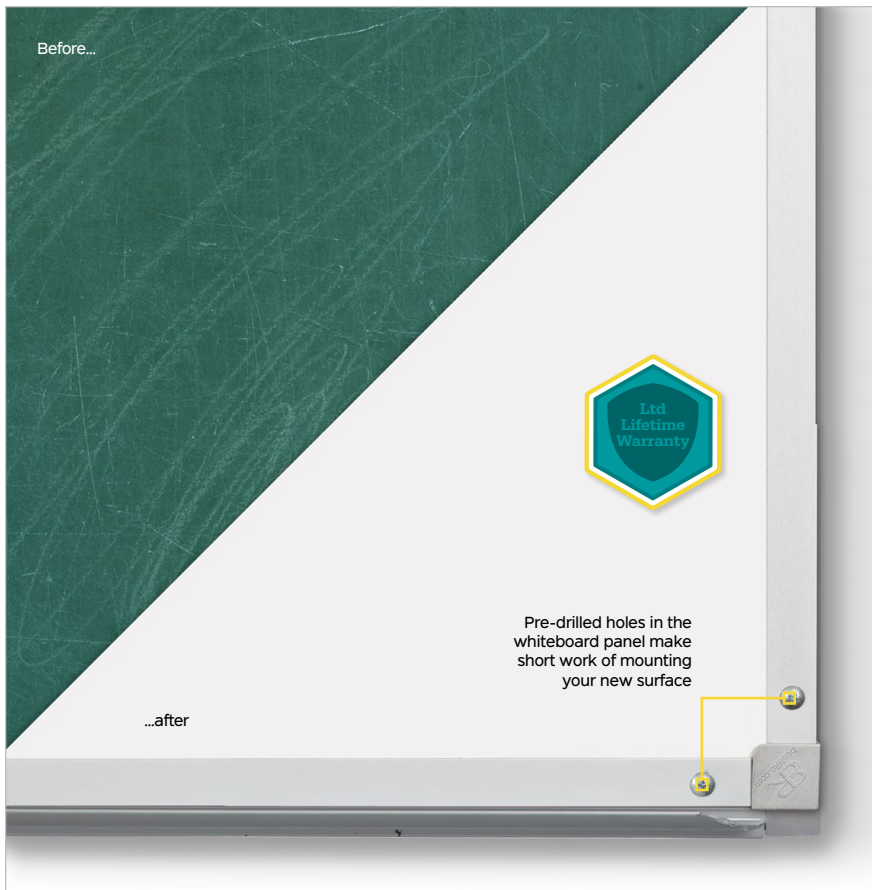

Porcelain Steel Retro-Finish Panel

- Porcelain Steel Retro-Finish Panels make short work of resurfacing any old chalkboard or markerboard.
- No need to remove the existing board. Simply drill the Retro-Finish panel directly into the old board. Factory framed panels come with pre-drilled holes to make mounting easy.
- Standard gloss porcelain provides superior writability and erasability with no ghosting. Reduced surface light distortion enhances visibility to provide optimum eye comfort.
- Limited lifetime warranty. SCS Indoor Advantage Gold Certified.

PART NO.	DIMENSIONS	SHIP WT.
2R2AX-25	per sq. ft.	3 lbs

[VIEW ONLINE](#)



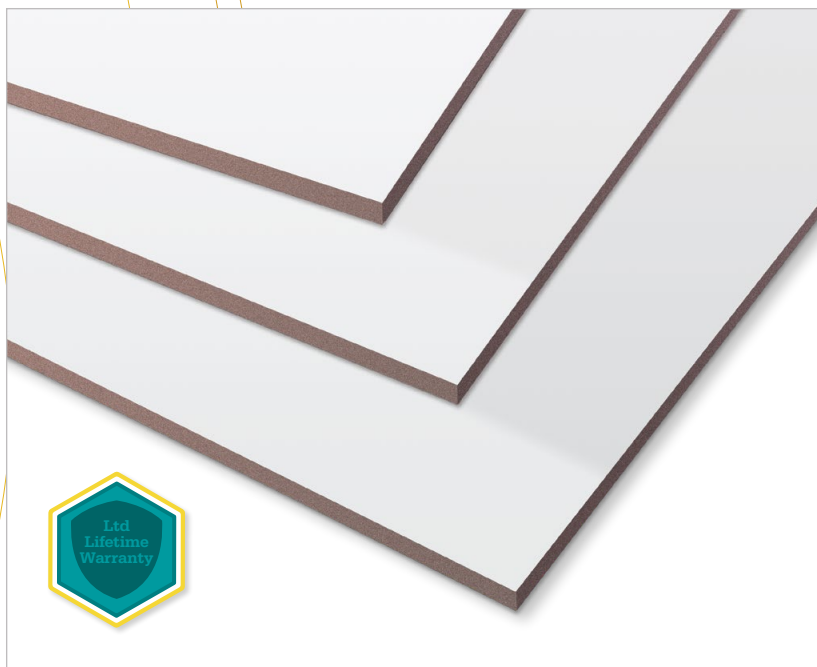

Unframed Porcelain Steel Whiteboard Panel

- Renew or replace any torn or worn board with whiteboard panels.
- Magnetic porcelain steel dry erase surface is engineered for superior color contrast with dry erase markers.
- Porcelain steel layer is permanently laminated to durable and moisture-resistant substrate, retaining rigidity while staying easy to handle.
- Available in ¼" or ½" thick panels. Limited lifetime warranty.
- Cover bar available to cover seams.
- Panel roller and adhesive available to ensure easy installation.
- SCS Indoor Advantage Gold Certified.

[VIEW ONLINE](#)

PART	DESCRIPTION	DIMENSIONS	SHIP WT.
PRODUCT			
202X	Porcelain Steel Whiteboard (½") - Unframed (Foil Back)	per sq. ft.	5 lbs
203X	Porcelain Steel Whiteboard (½") - Unframed (Sheet Back)	per sq. ft.	5 lbs
2H2X	Porcelain Steel Whiteboard (¼") - Unframed	per sq. ft.	3 lbs
80-TM	Cover Bar for Porcelain Steel Panel Seams	per linear ft.	1 lb
545	Panel Roller	9"H x 9"W	5 lbs
531	Panel Adhesive	16 sq. ft.	4 lbs



Whiteboard Self-Adhesive Skin

- Replace or renew any torn or worn board with whiteboard self-adhesive skins, designed to make markerboard resurfacing easy, with no mess or fumes.
- **Porcelain Steel:** High quality skins are made from 24-gauge steel. Standard gloss porcelain provides superior writability and erasability with no ghosting. Reduced surface light distortion enhances visibility to provide optimum eye comfort.
- **Dura-Rite:** High quality skins are made from Dura-Rite HPL for a tough and erasable surface that will provide years of use.
- Self-adhesive skins feature a peel-and-stick backing that applies easily to an existing board. Self-stick adhesive is intended for resurfacing on an existing board surface and has not been tested for use on other materials.
- Limited lifetime warranty on porcelain steel. Twenty year limited warranty on Dura-Rite®. SCS Indoor Advantage Gold Certified.

[VIEW ONLINE](#)

PART NO.	DESCRIPTION	DIMENSIONS	SHIP WT.
PRODUCT			
208SX	Porcelain Steel Whiteboard Self-Adhesive Skin (4H)	per sq. ft.	4 lbs
210SX	Porcelain Steel Whiteboard Self-Adhesive Skin (5H)	per sq. ft.	5 lbs
218S	Dura-Rite Self-Adhesive Skin	per sq. ft.	2 lbs

WALL SYSTEMS & RESURFACING: Tackboard



Natural Cork Panel

Natural Cork Roll



Natural Cork Self-Adhesive Skin

Natural Cork Resurfacing

- Renew or replace any torn or worn board with unframed tackboard panels, available in multiple surface and substrate options to fit any need, any budget, and any environment.
- Natural cork is an environmentally responsible and naturally renewable resource. Cork is harvested from a cork tree, stripped with careful cuts that do not harm the inner core of the tree. The cork bark regrows, and this process allows a useful life of more than 150 years for each tree.
- **Natural Add-Cork Panel:** Our select Add-Cork surface features a 1/8" thick cork layer bonded to 3/8" thick durable substrate material.
- **Natural Cork-Plate Panel:** Premium Cork-Plate surface is our top of the line option, featuring a full 1/4" thick cork layer bonded to 1/4" thick rigid and moisture-resistant substrate material.
- **Natural Cork Roll:** Rolls are available either cut to size or in precut sizes. Please add fiberboard or other appropriate backer to allow for use as tack surface. Adhesive for rolls sold separately.
- **Natural Cork Self-Adhesive Skin:** Self-adhesive skins feature a peel-and-stick backing that applies easily to an existing board. Self-stick adhesive is intended for resurfacing on an existing board surface and has not been tested for use on other materials.

[VIEW ONLINE](#)

PART	DESCRIPTION	DIMENSIONS	SHIP WT.
NATURAL CORK PANEL			
302X	Natural Add-Cork Panel - Unframed	per sq. ft.	1 lb
303X	Natural Cork-Plate Panel - Unframed	per sq. ft.	2 lbs
NATURAL CORK ROLL			
NCK406	Natural Cork Roll	4H x 6W	9 lbs
NCK408	Natural Cork Roll	4H x 8W	12 lbs
NCK412	Natural Cork Roll	4H x 12W	18 lbs
NCK424	Natural Cork Roll	4H x 24W	36 lbs
NATURAL CORK SELF-ADHESIVE SKIN			
308JX	Natural Cork Self-Adhesive Skin (1/4")	per sq. ft.	1 lb

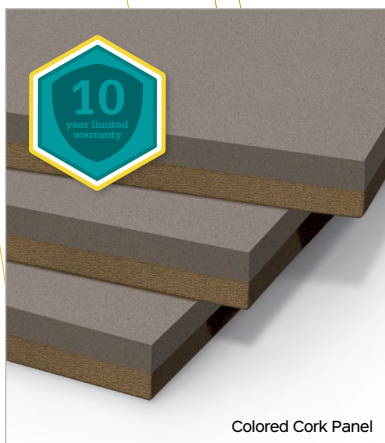

Colored Cork Panel

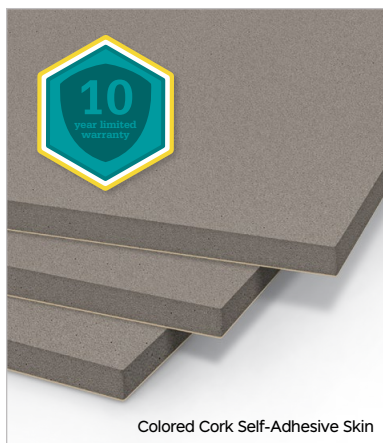

Colored Cork Self-Adhesive Skin

PART	DESCRIPTION	DIMENSIONS	SHIP WT.
PRODUCT			
322X	Colored Cork Tackboard - Unframed	per sq. ft.	2 lbs
325JX	Colored Cork Self-Adhesive Skin	per sq. ft.	1 lb

Colored Cork Resurfacing

- Renew or replace any torn or worn board with Colored Cork, made with colorful and durable Forbo® linoleum.
- Surface is self-healing and colored throughout to ensure colorfastness and eliminate fading.
- Panels are made with ¼" thick Colored Cork permanently adhered to a ¼" thick layer of rigid substrate.
- Self-adhesive skins feature a peel-and-stick backing that applies easily to an existing board. Self-stick adhesive is intended for resurfacing on an existing board surface and has not been tested for use on other materials.
- Ten year limited warranty. SCS Indoor Advantage Gold Certified.

[VIEW ONLINE](#)



Vinyl Panels

- Low-maintenance fabric-backed vinyl material is durable and easy to clean. Vinyl is also treated to resist the growth of stain- and odor-causing microbes, and is available in multiple colors to coordinate with any environment.
- **Vin-Tak:** Vin-Tak features vinyl adhered to ⅞" lightweight and tackable substrate material.
- **Vinyl Add-Cork:** Features vinyl adhered to a ⅞" thick cork layer bonded to ⅜" thick durable substrate material.
- **Vinyl Cork-Plate:** Features vinyl adhered to a full ¼" thick cork layer bonded to ¼" thick rigid substrate material.
- Ten year limited warranty on all panels. SCS Indoor Advantage Gold Certified.

[VIEW ONLINE](#)

PART	DESCRIPTION	DIMENSIONS	SHIP WT.
PRODUCT			
311X	Vin-Tak Tackboard - Unframed (Cut Edge)	per sq. ft.	1 lb
314E	Vin-Tak Tackboard - Unframed (Wrapped Edge)	per sq. ft.	1 lb
312X	Vinyl Covered Add-Cork - Unframed	per sq. ft.	1 lb
313X	Vinyl Covered Cork-Plate - Unframed	per sq. ft.	2 lbs

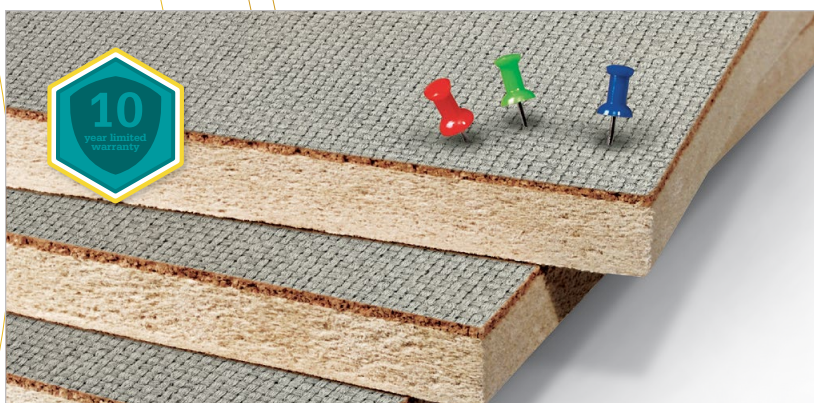

Fabric Panels

- Featuring a polyolefin fabric that is washable, treated to resist the growth of stain- and odor-causing microbes, and unaffected by most common household chemicals, salts, and cleansers, fabric panels also soften any space with sound-dampening qualities
- **Fab-Tak:** Vin-Tak features vinyl adhered to ⅞" lightweight and tackable substrate material.
- **Fabric Add-Cork:** Features fabric adhered to a ⅞" thick cork layer bonded to ⅜" thick durable substrate material.
- **Fabric Cork-Plate:** Features fabric adhered to a ¼" thick cork layer bonded to ¼" thick rigid substrate material.
- Ten year limited warranty on all panels. SCS Indoor Advantage Gold Certified.

[VIEW ONLINE](#)

PART	DESCRIPTION	DIMENSIONS	SHIP WT.
PRODUCT			
331X	Fab-Tak Tackboard - Unframed (Cut Edge)	per sq. ft.	1 lb
334E	Fab-Tak Tackboard - Unframed (Wrapped Edge)	per sq. ft.	1 lb
332X	Fabric Covered Add-Cork - Unframed	per sq. ft.	1 lb
333X	Fabric Covered Cork-Plate - Unframed	per sq. ft.	2 lbs

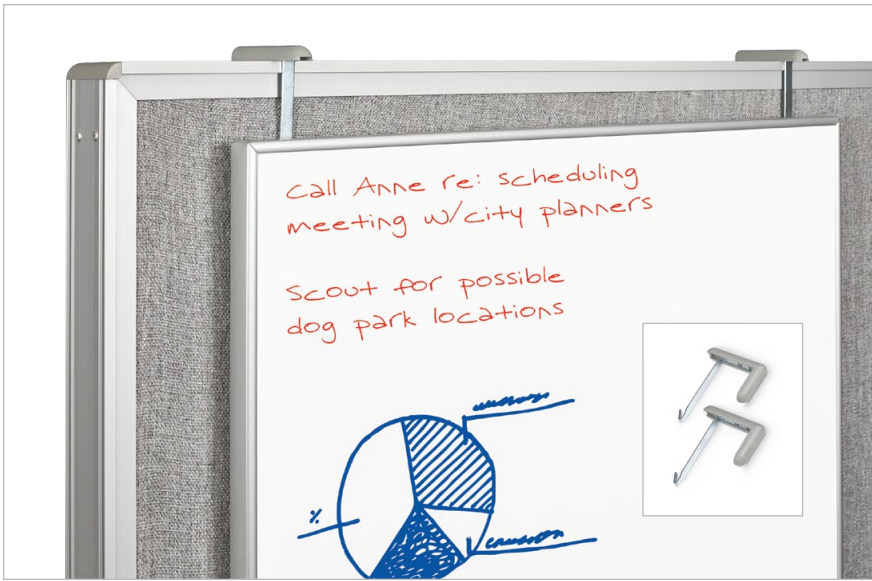

Cubicle Board Hanger

- Mount a whiteboard, tackboard, framed photograph, or artwork to your cubicle with ease and without using any damaging materials, tacks, or sticky substances.
- Lightweight hangers fit securely over most cubicle partitions, providing quick and easy accessibility. Easy to mount and unmount. A set holds up to 50 lbs.
- Screw adjustment allows hanger to fit wall thicknesses from 1" to 2-1/2". Sold in sets of two.
- SCS Indoor Advantage Gold Certified.

PART NO.	DESCRIPTION	SHIP WT.
56389	Cubicle Board Hanger (set of 2)	2 lbs

[VIEW ONLINE](#)



Glass Accessory Tray

- Glass tray coordinates with virtually any of our glass board options.
- Attractive tray keeps your markers and erasers close at hand.
- Durable white glass finish adds sparkle to your glass board.
- SCS Indoor Advantage Gold Certified.

PART NO.	DIMENSIONS	SHIP WT.
572	1"H x 12"W x 4"D	2 lbs

[VIEW ONLINE](#)



Magnetic Accessory Tray

- Keep your markers, erasers, and other whiteboard accessories close at hand with a magnetic accessory tray.
- Magnetic accessory trays attach to any surface that accepts magnets for instant and convenient marker and eraser storage. Measures 12" wide. Purchase two or more for larger boards.
- For use on standard magnetic whiteboards only. For magnetic glass boards use rare earth magnets.
- SCS Indoor Advantage Gold Certified.

PART NO.	DIMENSIONS	SHIP WT.
MT-12G	1.3"H x 12"W x 2.3"D	2 lbs

[VIEW ONLINE](#)

Magnetic Q-Tray

- Keep your markers, erasers, and other whiteboard accessories close at hand with a Magnetic Q-Tray.
- Magnetic accessory tray attaches to any surface that accepts magnets for instant and convenient marker and eraser storage. Measures 16" wide. Purchase two or more for larger boards.
- For use on standard magnetic whiteboards only. For magnetic glass boards use rare earth magnets.
- SCS Indoor Advantage Gold Certified.



PART NO.	DIMENSIONS	SHIP WT.
MT-16	1.3"H x 16"W x 2.5"	2 lbs

[VIEW ONLINE](#)

Magnetic Eraser Cloth

- Magnetic Eraser Cloth wipes away dry erase marker ink cleanly and with no ghosting.
- Cloth features a magnet sewn into one corner to easily attach to any surface that accepts magnets.
- Ideal for boards without a tray, the cloth conveniently stores wherever it is needed.
- SCS Indoor Advantage Gold Certified.



PART NO.	DIMENSIONS	SHIP WT.
555	8"H x 8"W	1 lb

[VIEW ONLINE](#)



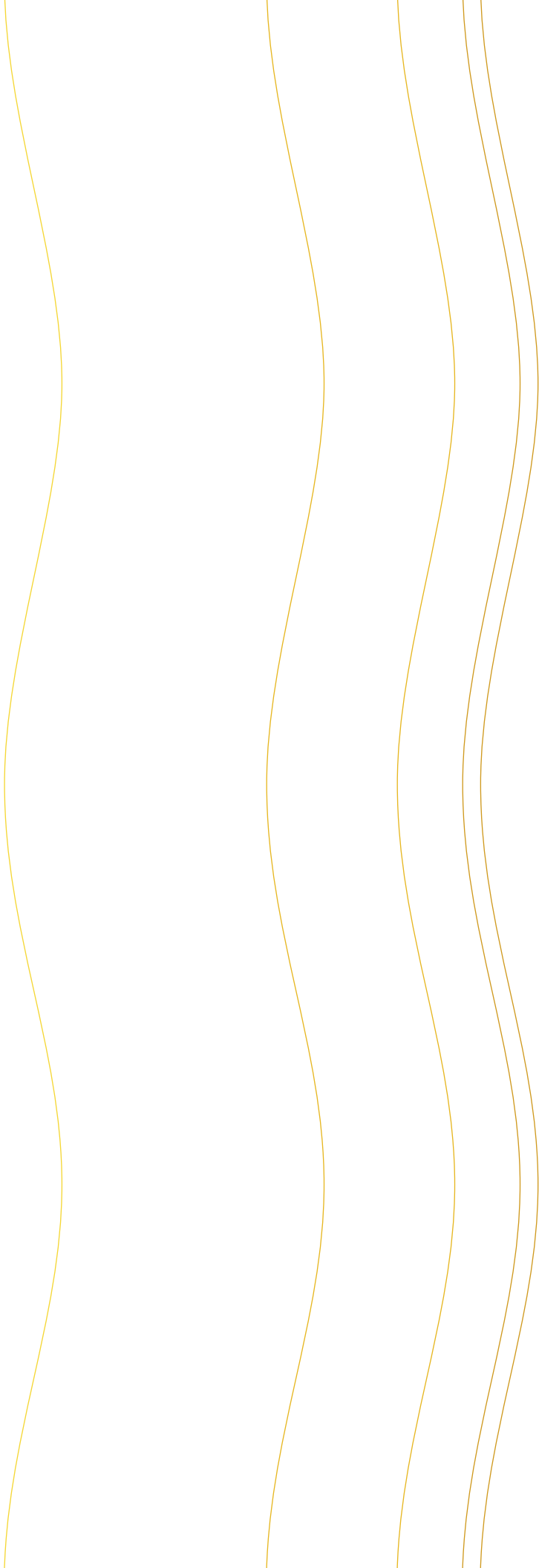

Follow us:



[instagram.com/mooreco_inc](https://www.instagram.com/mooreco_inc)



[pinterest.com/moorecoinc](https://www.pinterest.com/moorecoinc)



[facebook.com/moorecoinc](https://www.facebook.com/moorecoinc)



[linkedin.com/company/mooreco-inc](https://www.linkedin.com/company/mooreco-inc)



twitter.com/moorecoinc



[youtube.com/moorecoinc](https://www.youtube.com/moorecoinc)



[tiktok.com/@moorecoinc](https://www.tiktok.com/@moorecoinc)



MooreCo Inc.
2885 Lorraine Avenue | Temple, TX 76501
p: 800.749.2258 | f: 866.888.7483
www.moorecoinc.com